



Steps toward cell-like systems: spatio-temporal control of shared molecular resources for cell-free gene expression

patrick caveney
27 march 2019
dissertation defense

10 μm

10 μm

Outline

Chapter 1: Introduction

Chapter 2: Resource Sharing Controls Gene Expression Bursting

Chapter 3: Controlling Cell-Free Gene Expression Behavior by Tuning Membrane Transport Properties

Chapter 4: Conclusion

Biology offers many solutions to energy challenges

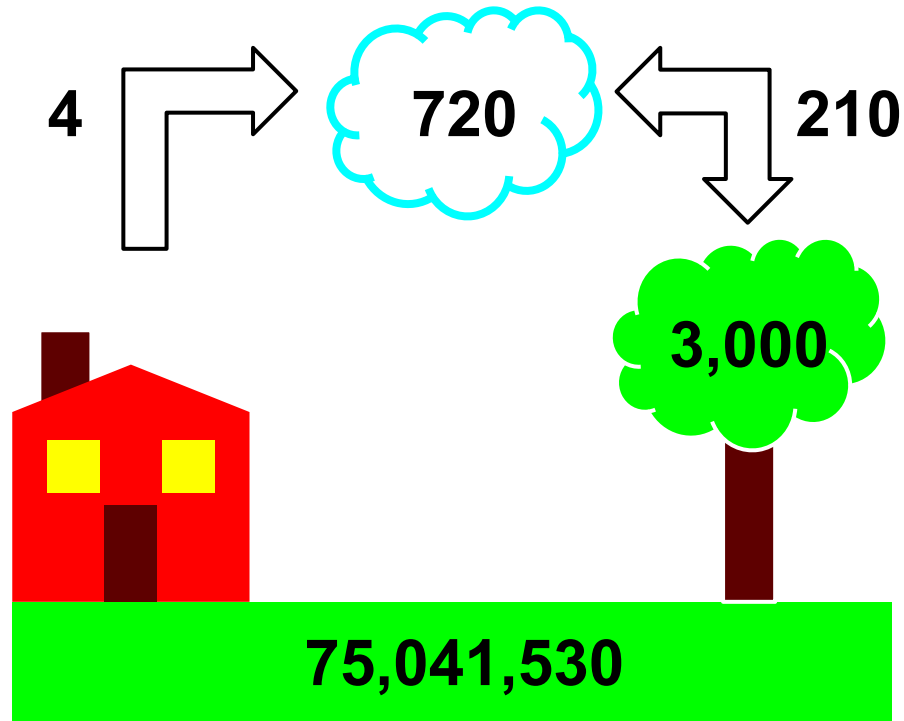

Natural systems are difficult to engineer

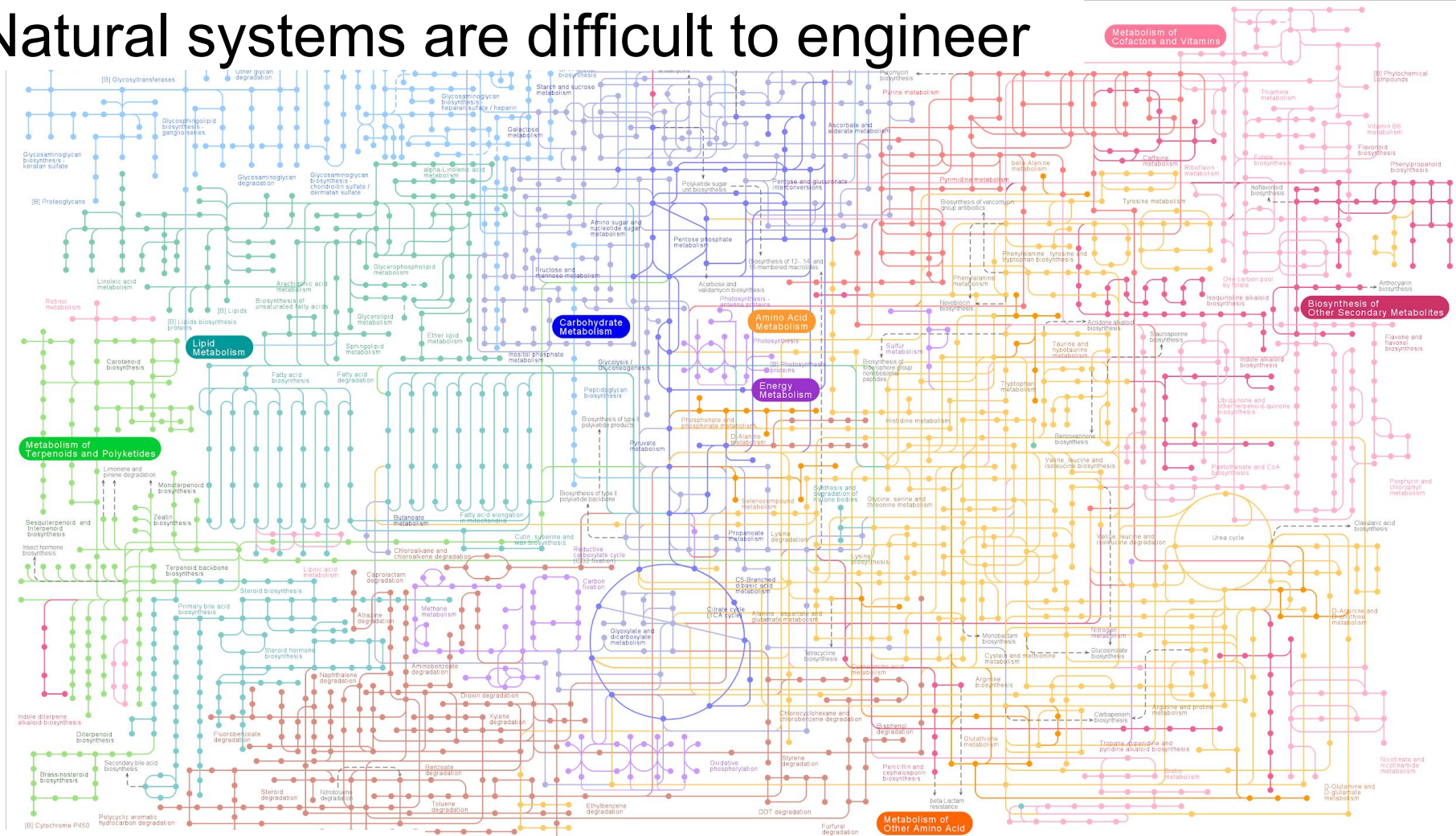

Biological systems are designed as circuits

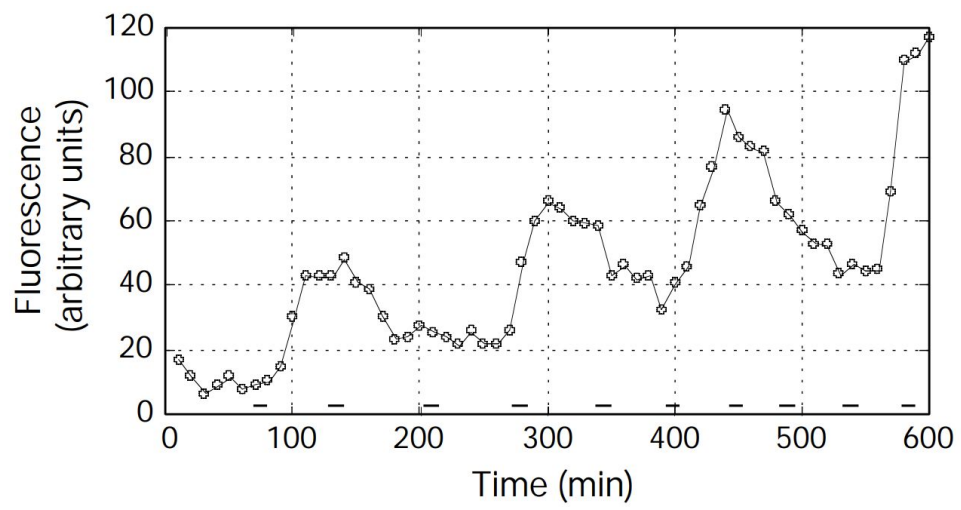
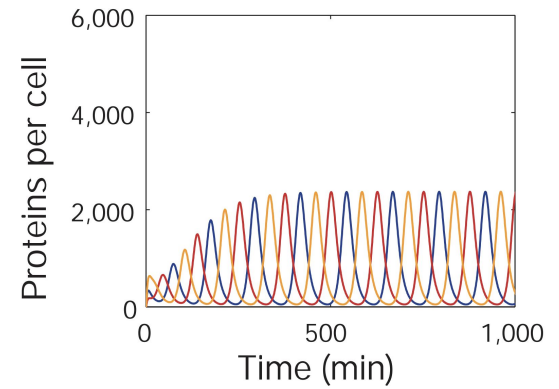
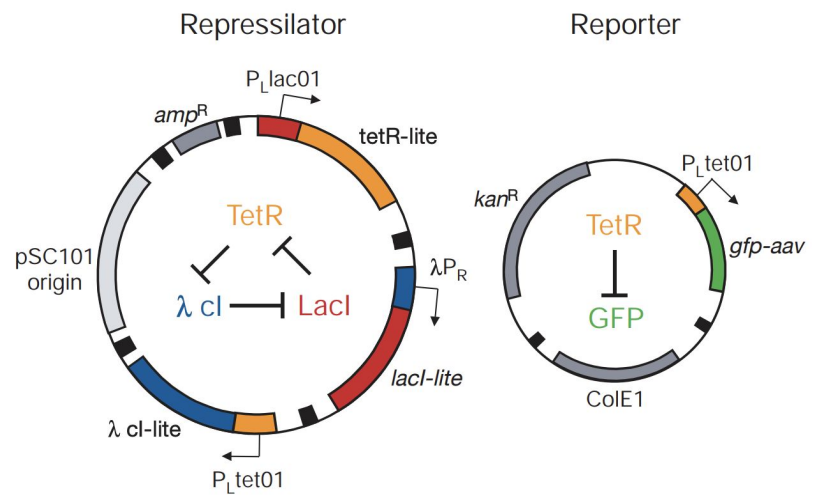

Gene expression is a noisy process

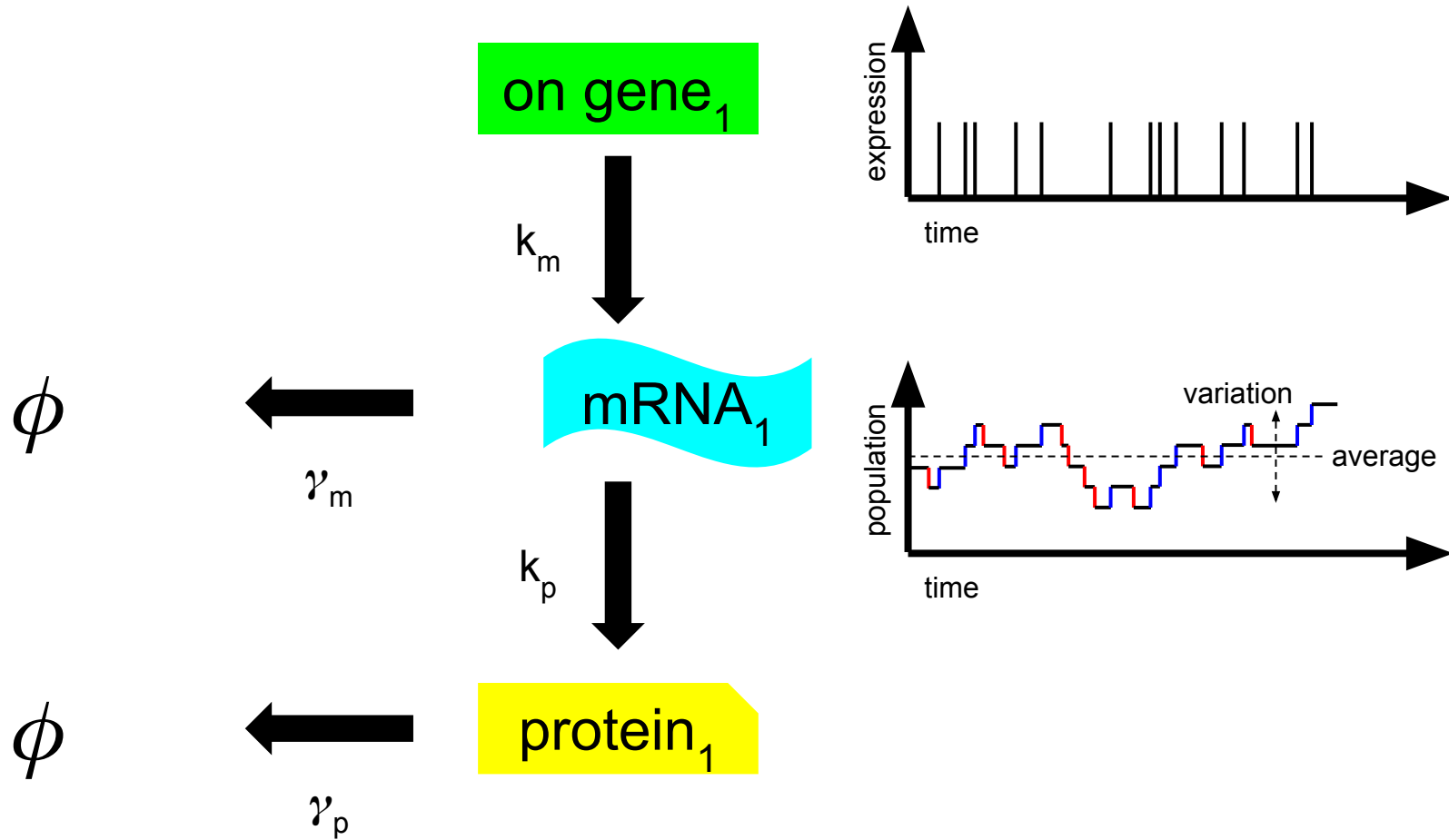

Expression bursting further contributes to noise

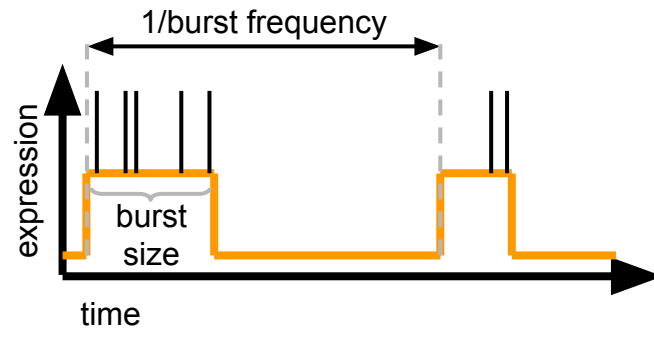
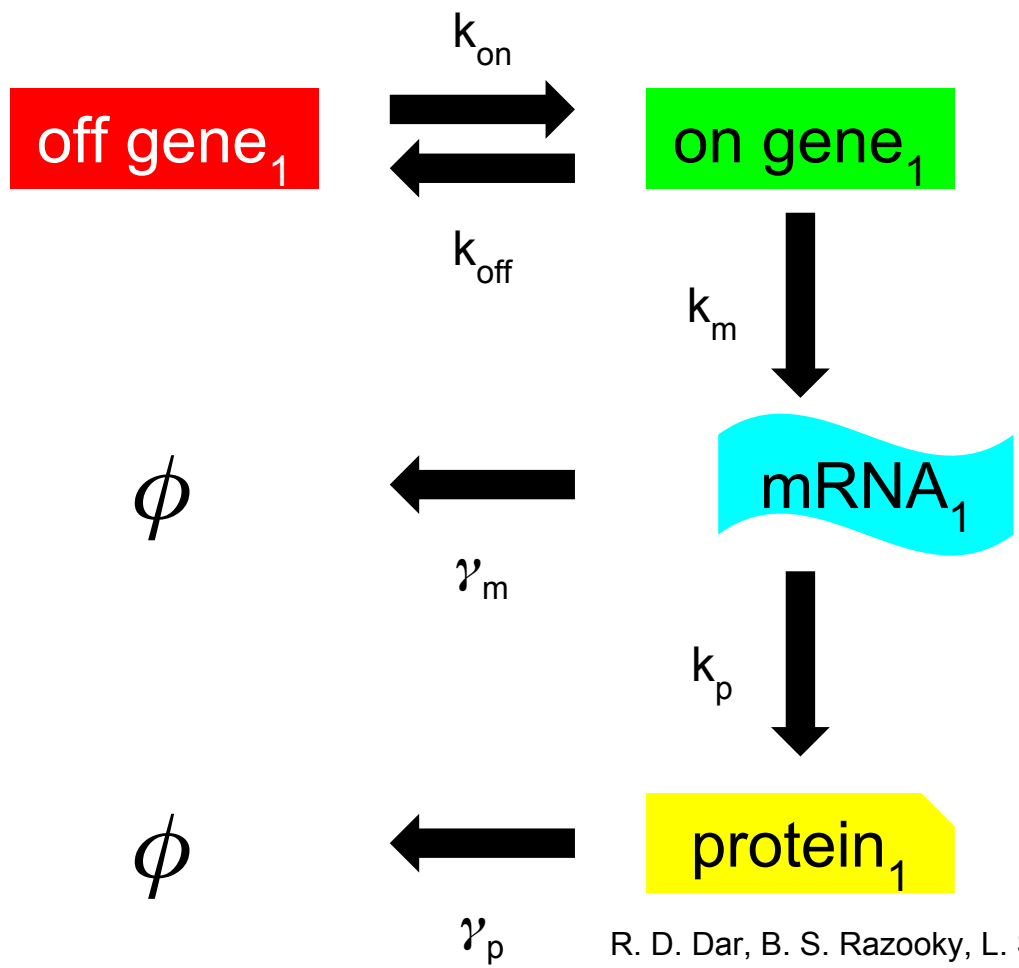

$$\langle p \rangle = \frac{Bf}{\gamma_p}$$

$$CV^2 \simeq \frac{\gamma_p}{f}$$

Burst size and frequency changes are measurable from protein expression data

$$CV^2 \simeq \frac{\gamma_p}{f}$$

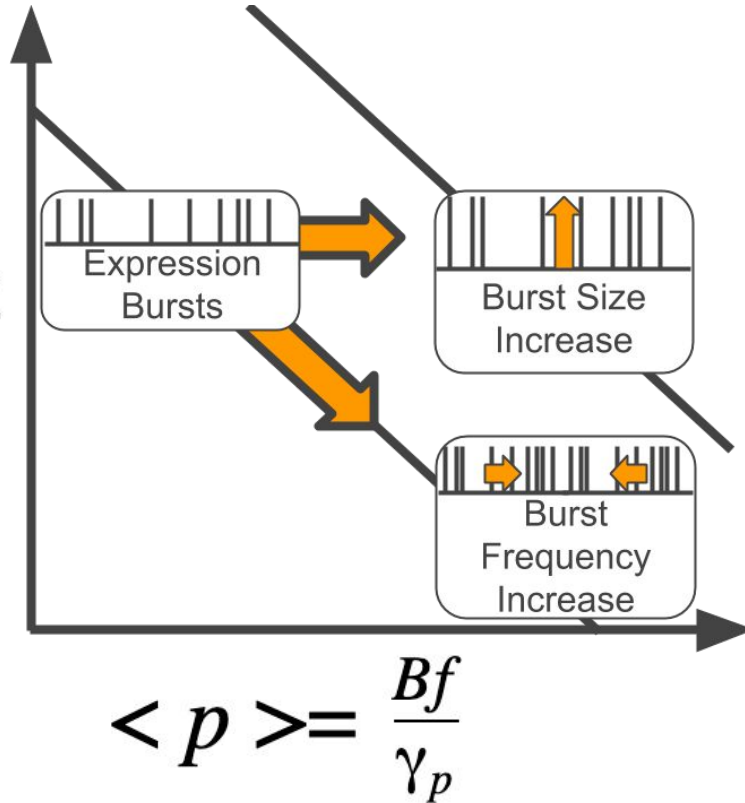

Protein abundance and variance of noise are key measures

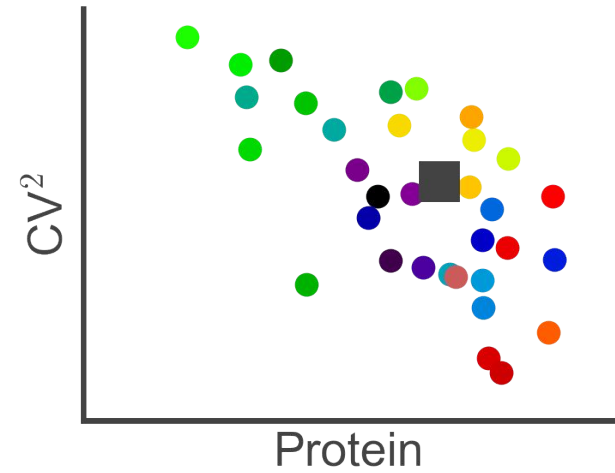
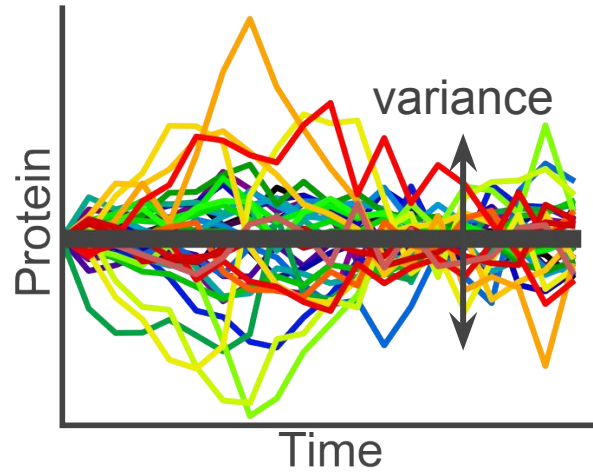
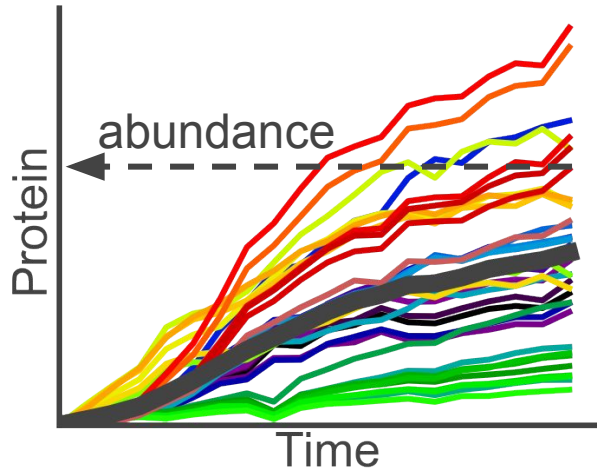

Protein expression requires resources

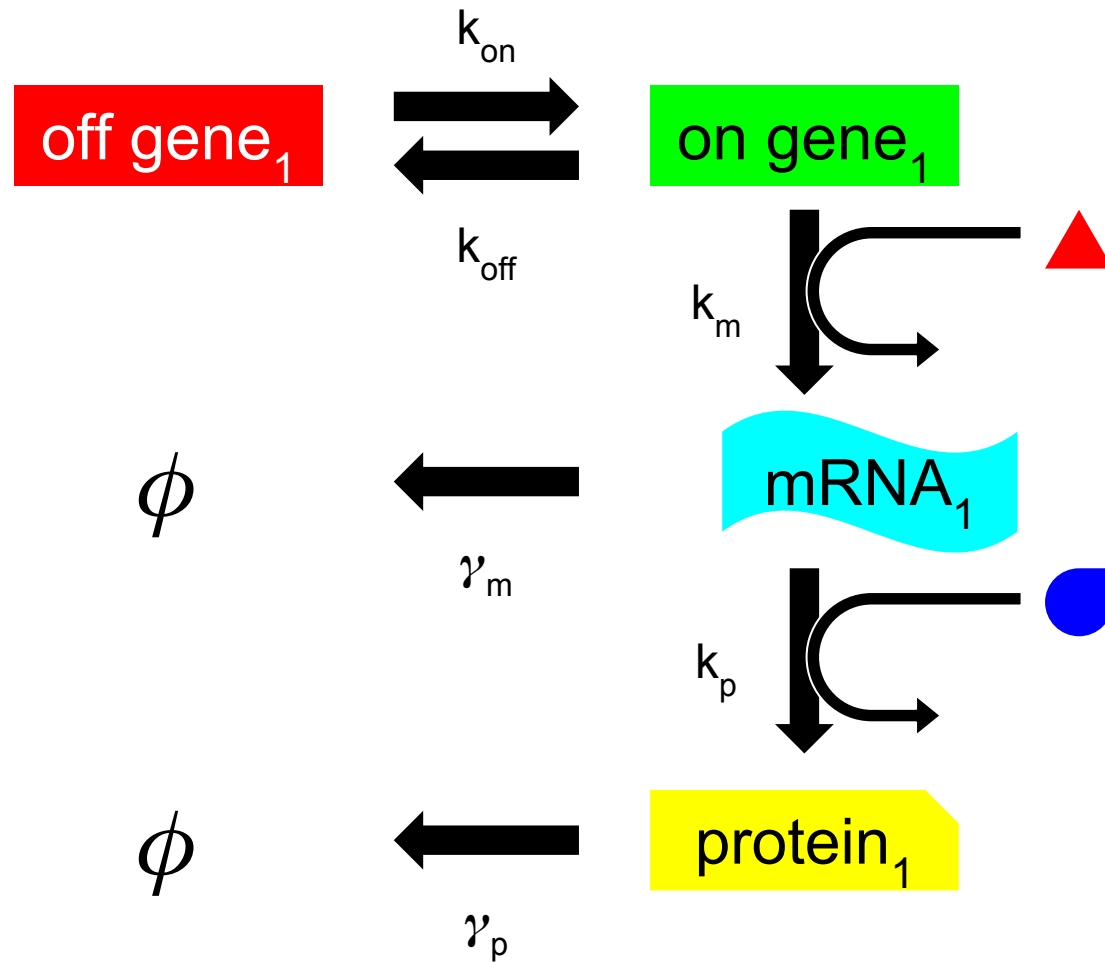

Expression resources are shared between genes

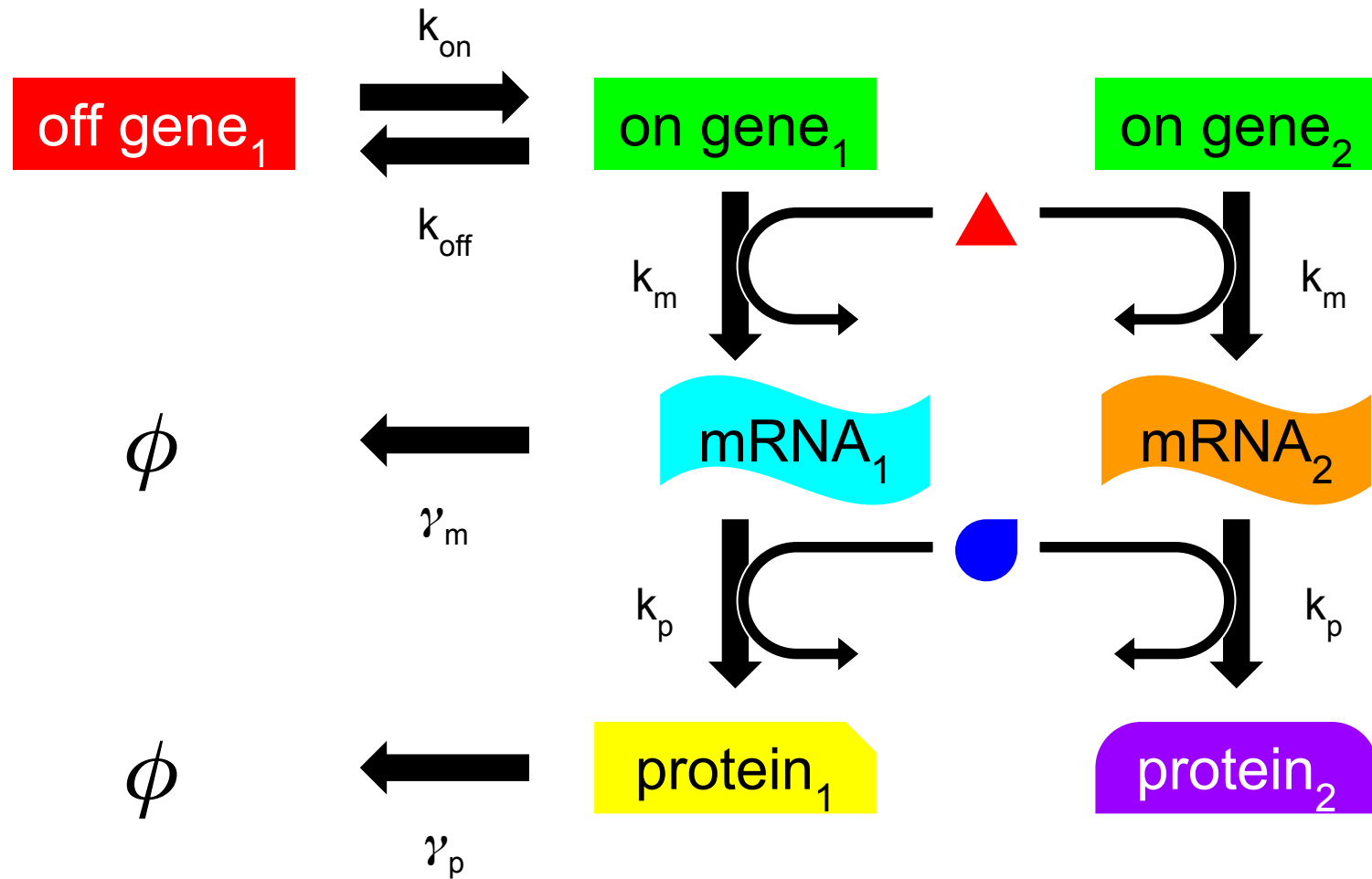

Resource sharing influences protein expression

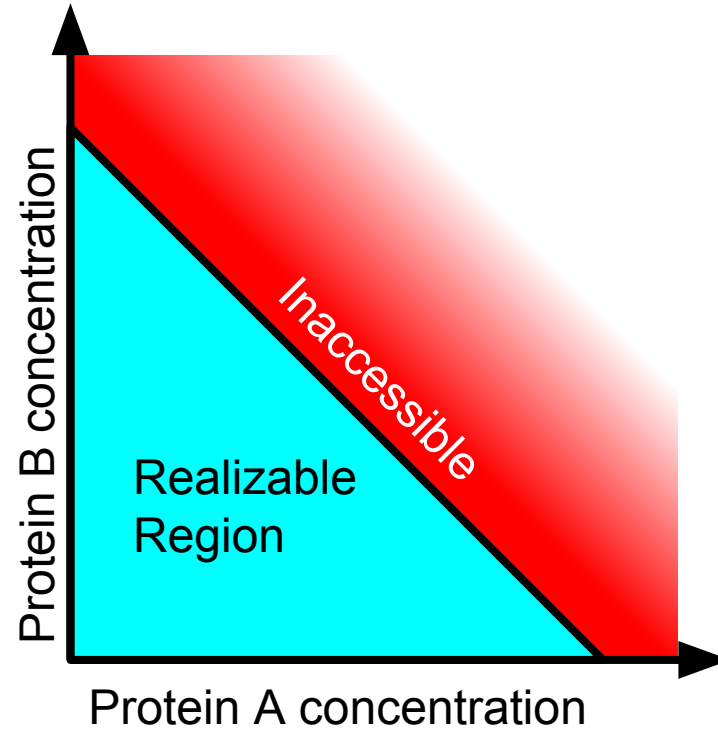
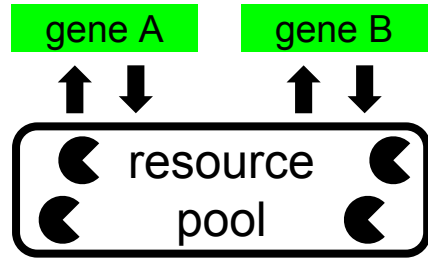

expression resources

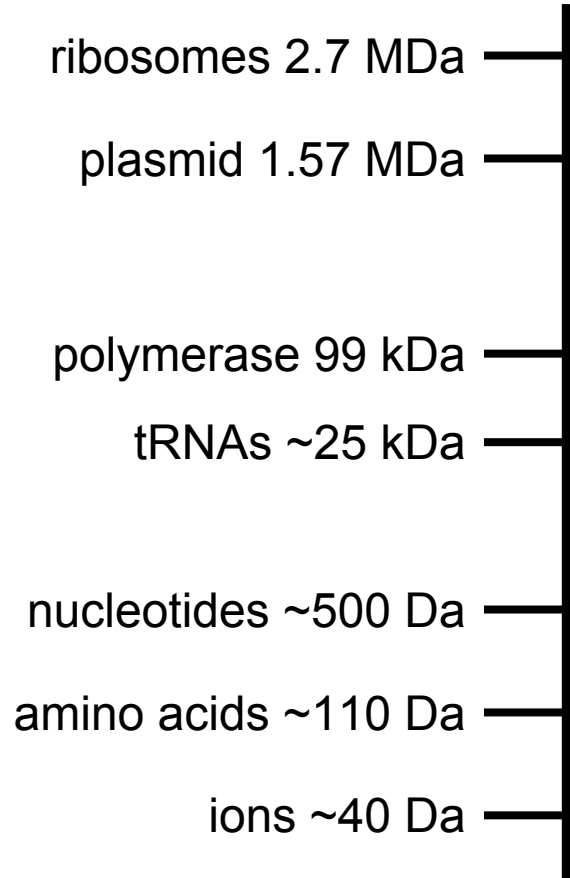

Cell-free protein expression systems allow fine control of the expression environment

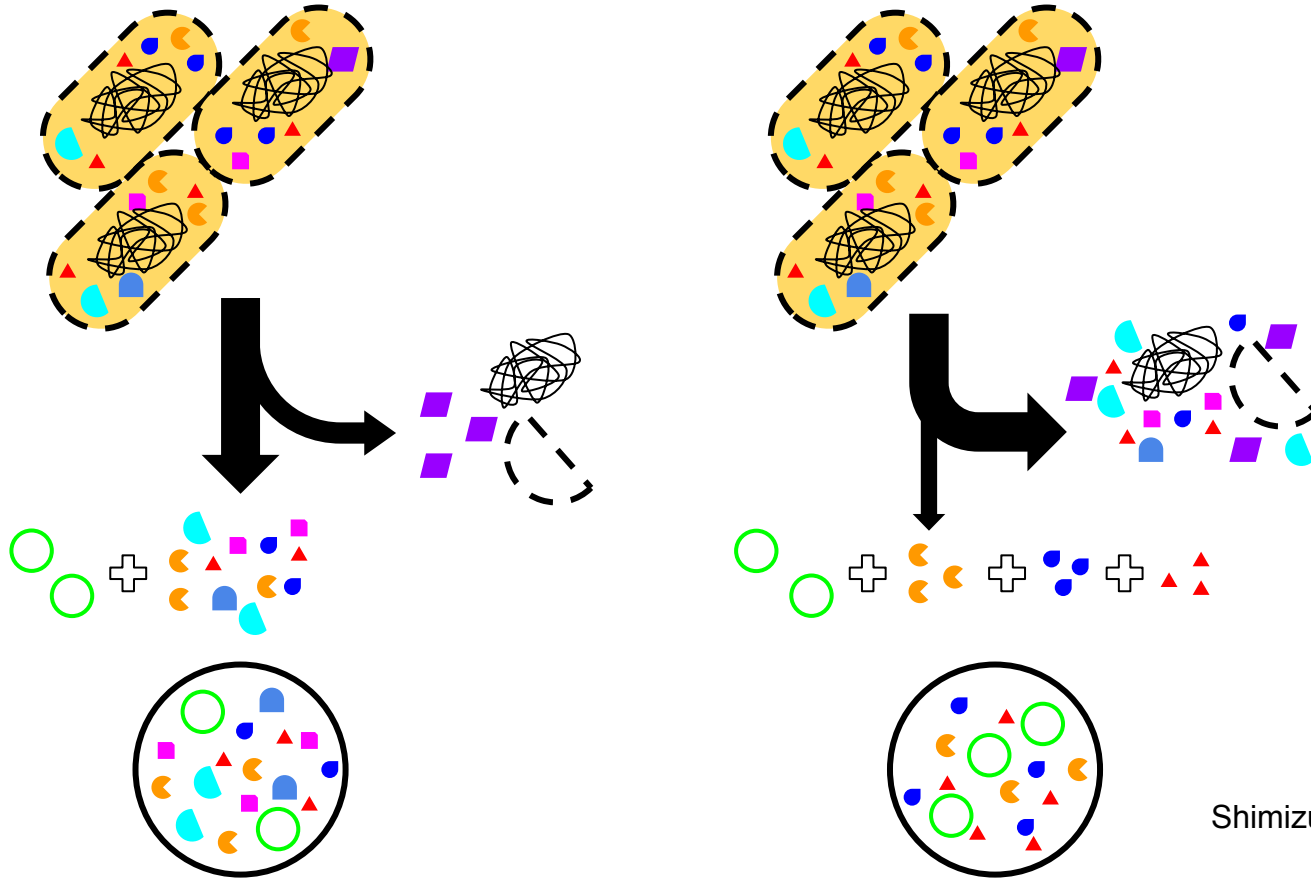

Microfluidic confinement of protein expression to cell-relevant volumes

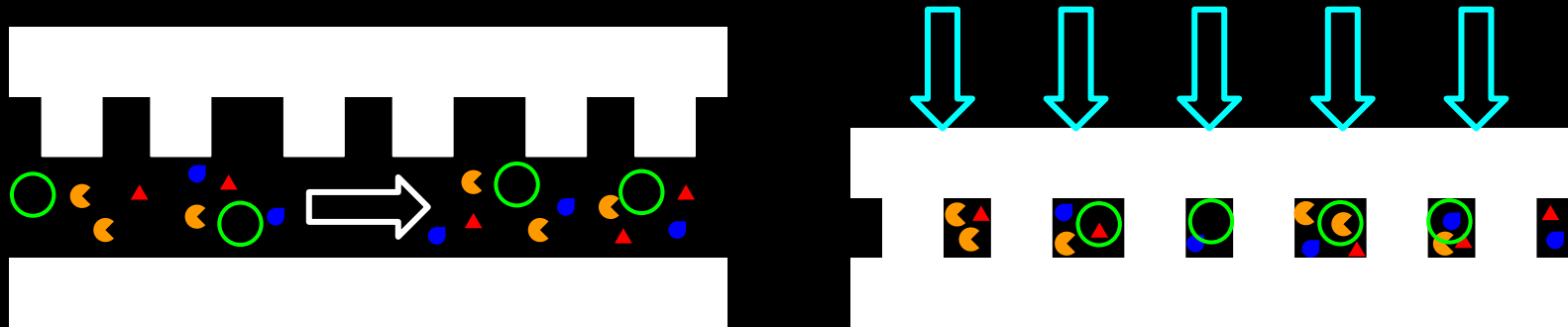
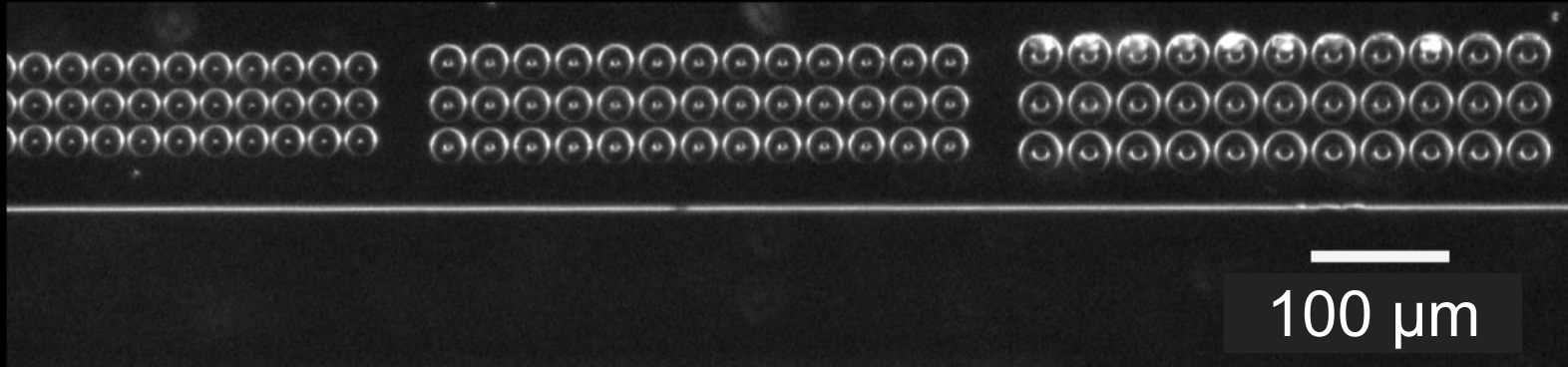

0 minutes

15 minutes

30 minutes

60 minutes

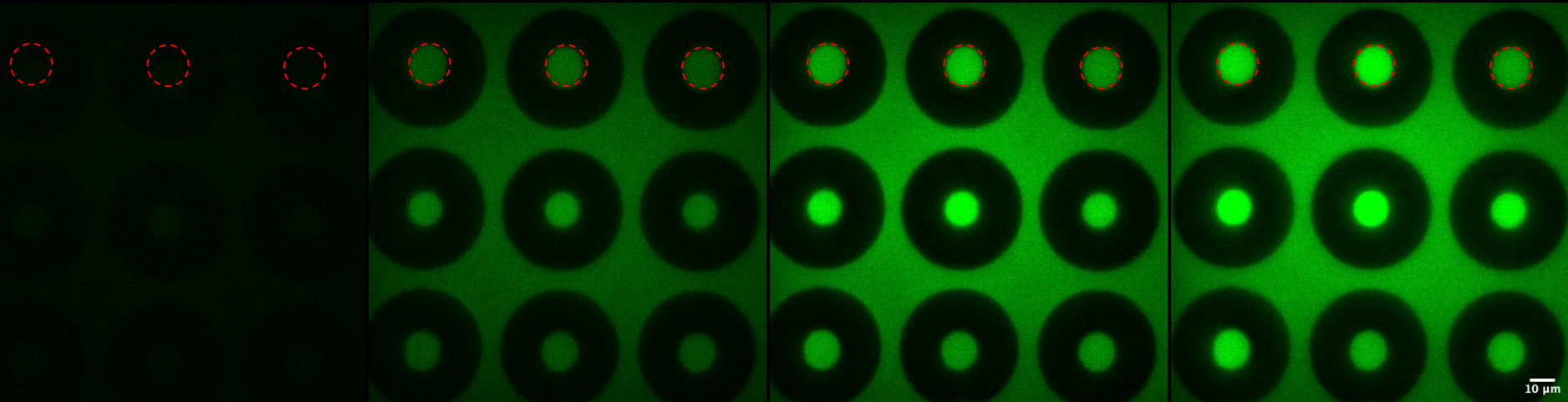

Vesicle confinement of protein expression to cell-relevant volumes

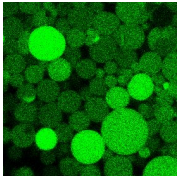
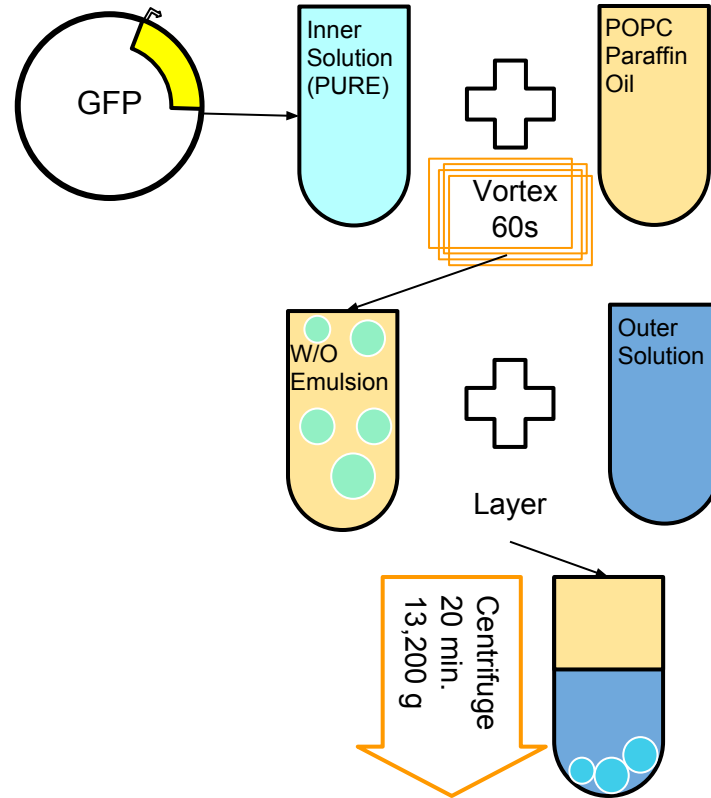

Dr. Brandon Razoogy

Nishimura, K., Matsuura, T., Sunami, T., Fujii, S., Nishimura, K., Suzuki, H., & Yomo, T. (2014)

0 minutes



15 minutes

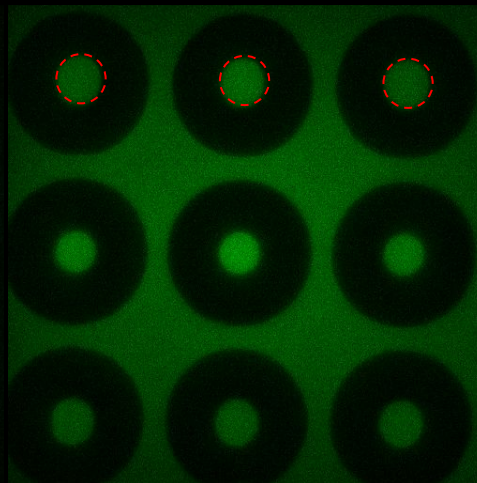

30 minutes

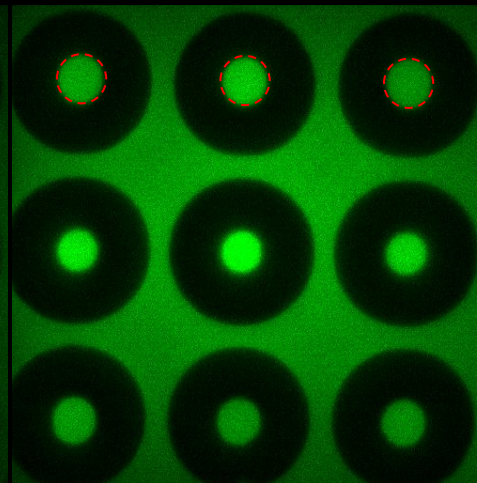

60 minutes

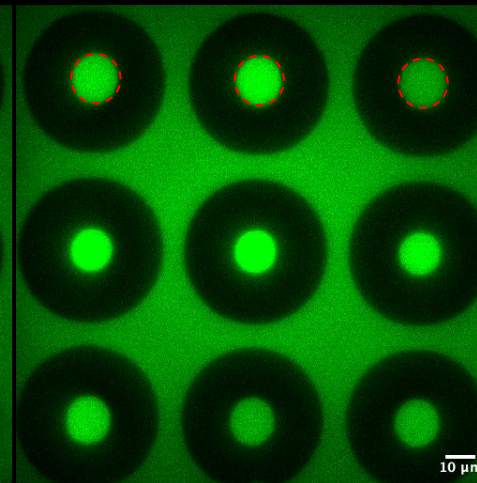

120 minutes

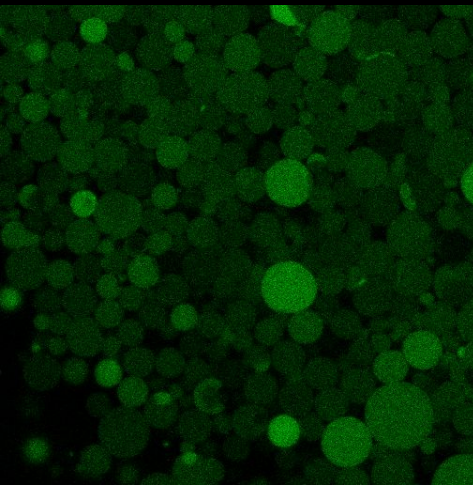

135 minutes

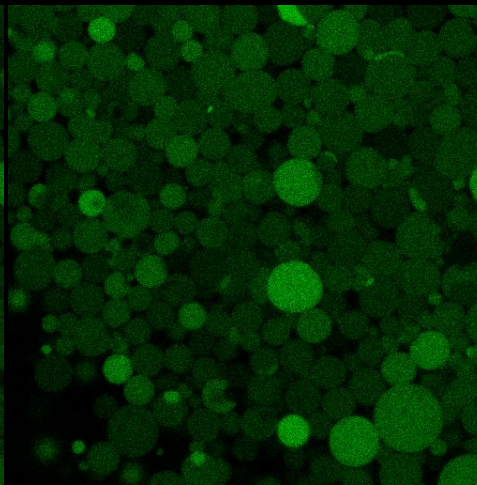

150 minutes

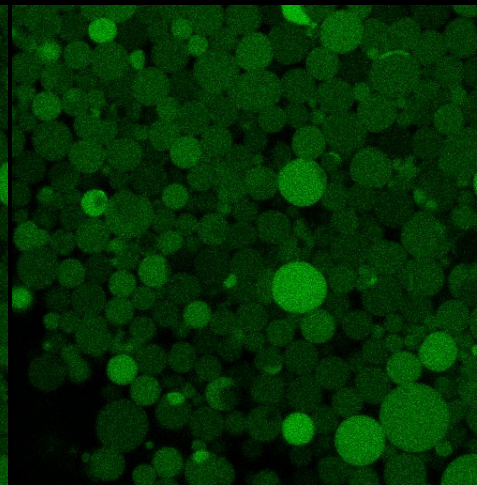

180 minutes

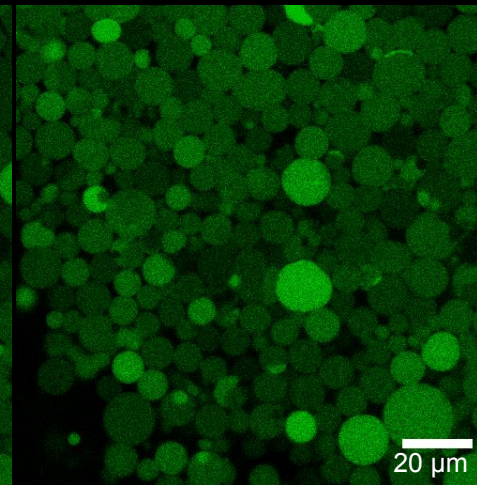

Purpose

The purpose of this dissertation is to investigate how gene expression bursting and variation is affected by expression resources being shared among genes.

1. How are gene expression characteristics altered by the size of resource pools?
2. Can membrane permeability be tuned to enhance gene expression?
3. How are the dynamics of gene expression affected by resource transport across permeabilized membranes?

Outline

Chapter 1: Introduction

Chapter 2: Resource Sharing Controls Gene Expression Bursting

Chapter 3: Controlling Cell-Free Gene Expression Behavior by Tuning Membrane Transport Properties

Chapter 4: Conclusion

Chapter 2: Resource Sharing Controls Gene Expression Bursting

Bursty expression and resource sharing are linked

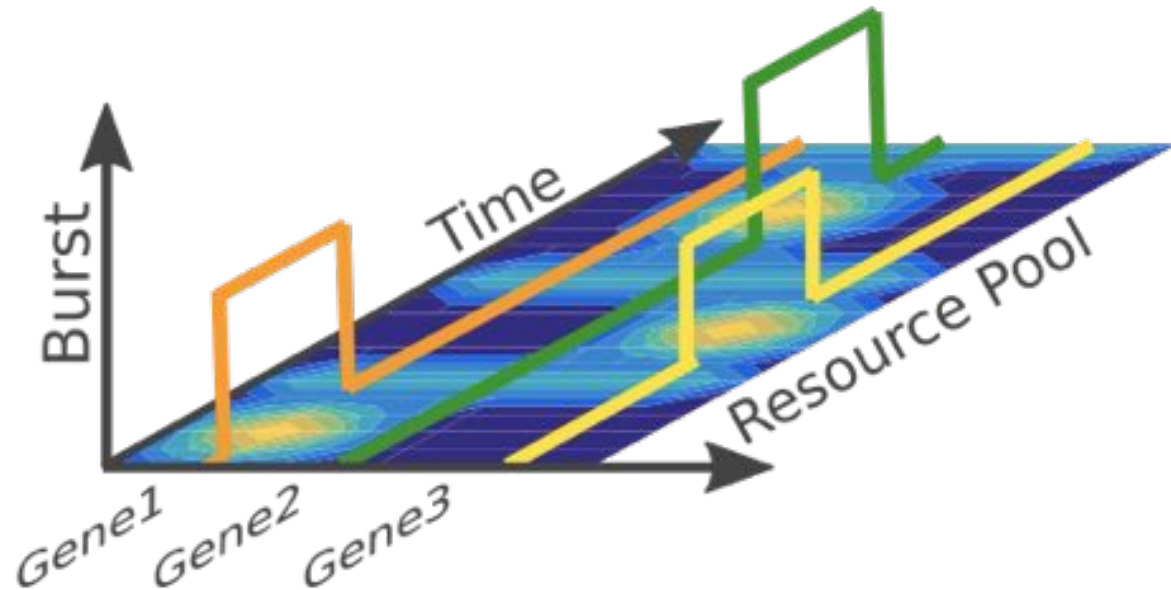

How does resource sharing affect bursty expression?

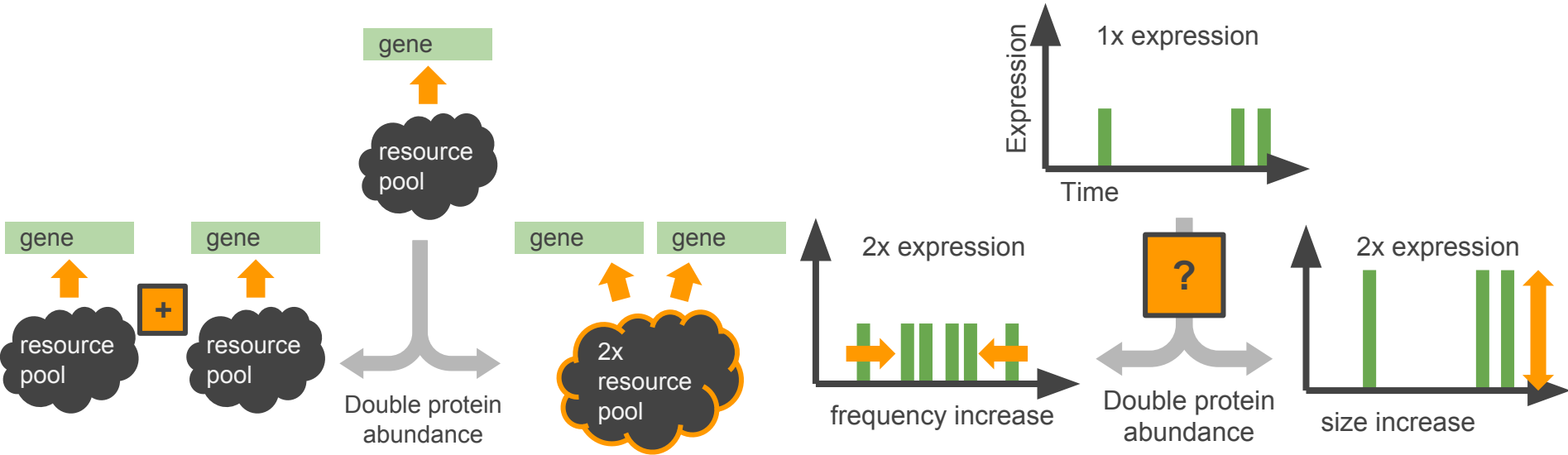

Burst size and frequency changes are measurable from protein expression data

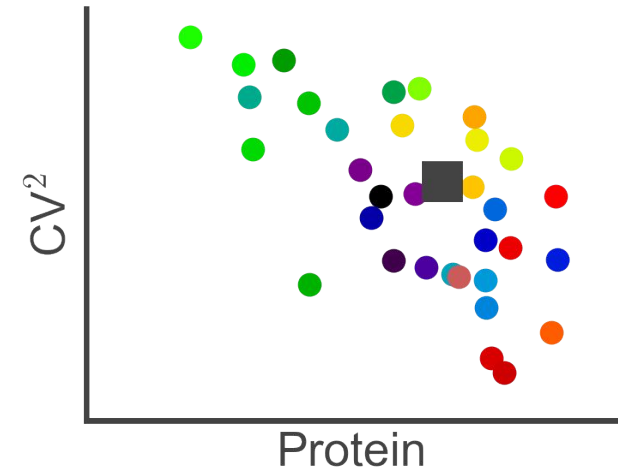
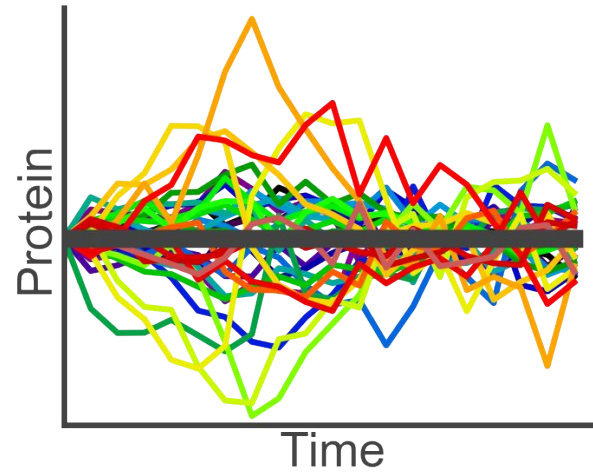
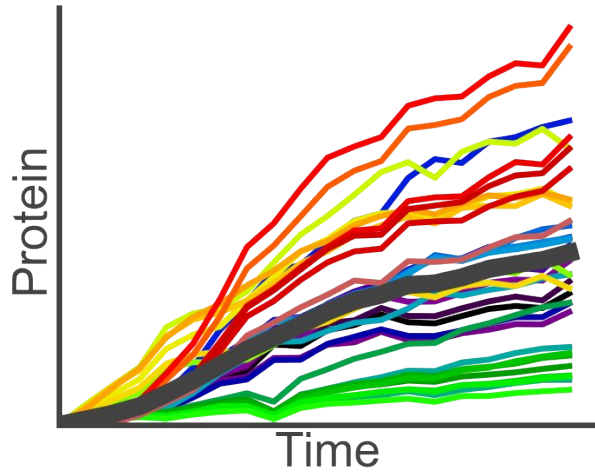

Karig, D. K., Jung, S. Y., Srijanto, B., Collier, C. P., & Simpson, M. L. (2013)
Sun, Z. Z., Hayes, C. A., Shin, J., Caschera, F., Murray, R. M., & Noireaux, V. (2013)

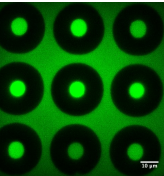

Divided resource pools increase burst frequency

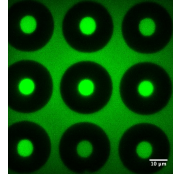
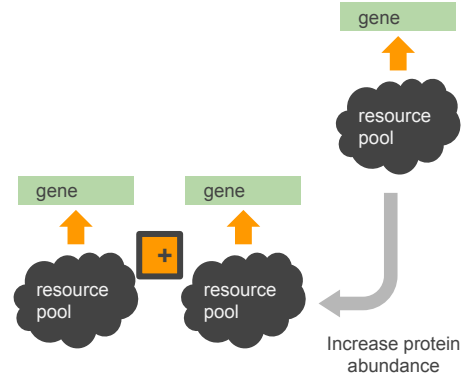
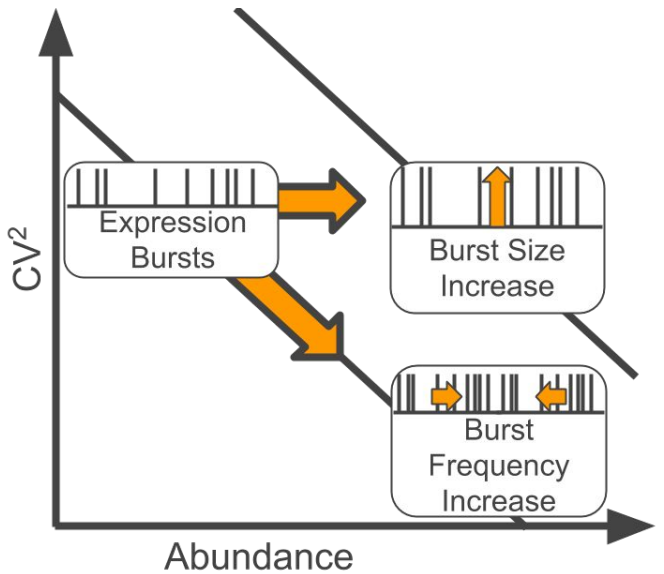
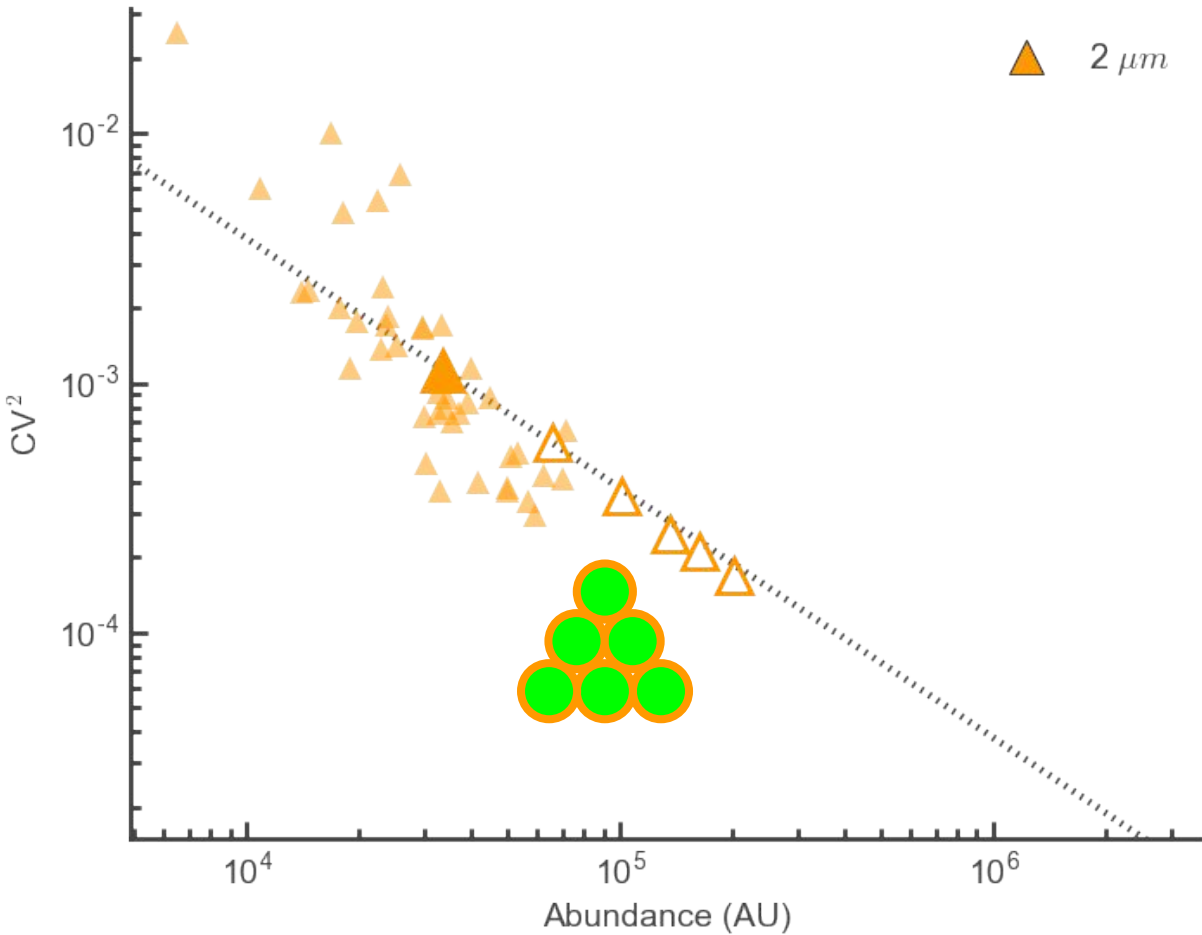

Larger chamber size result in larger burst size

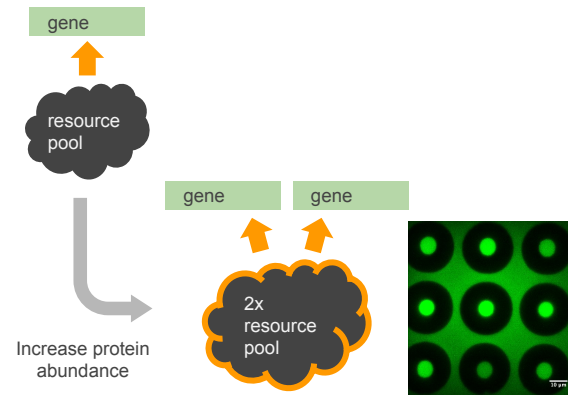
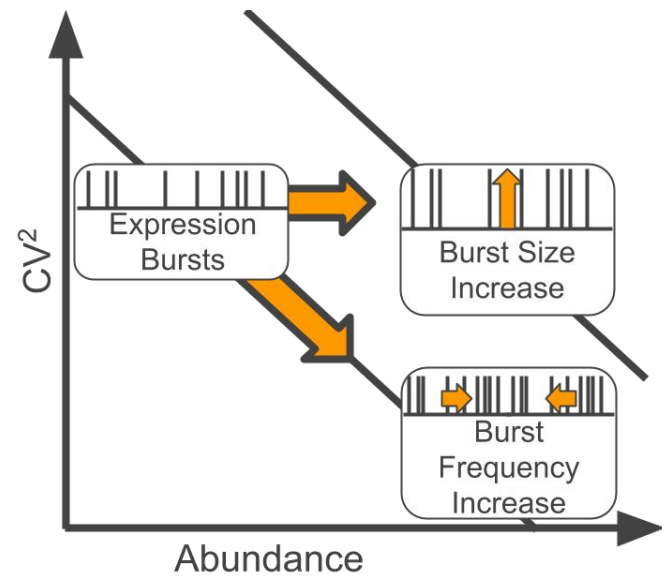
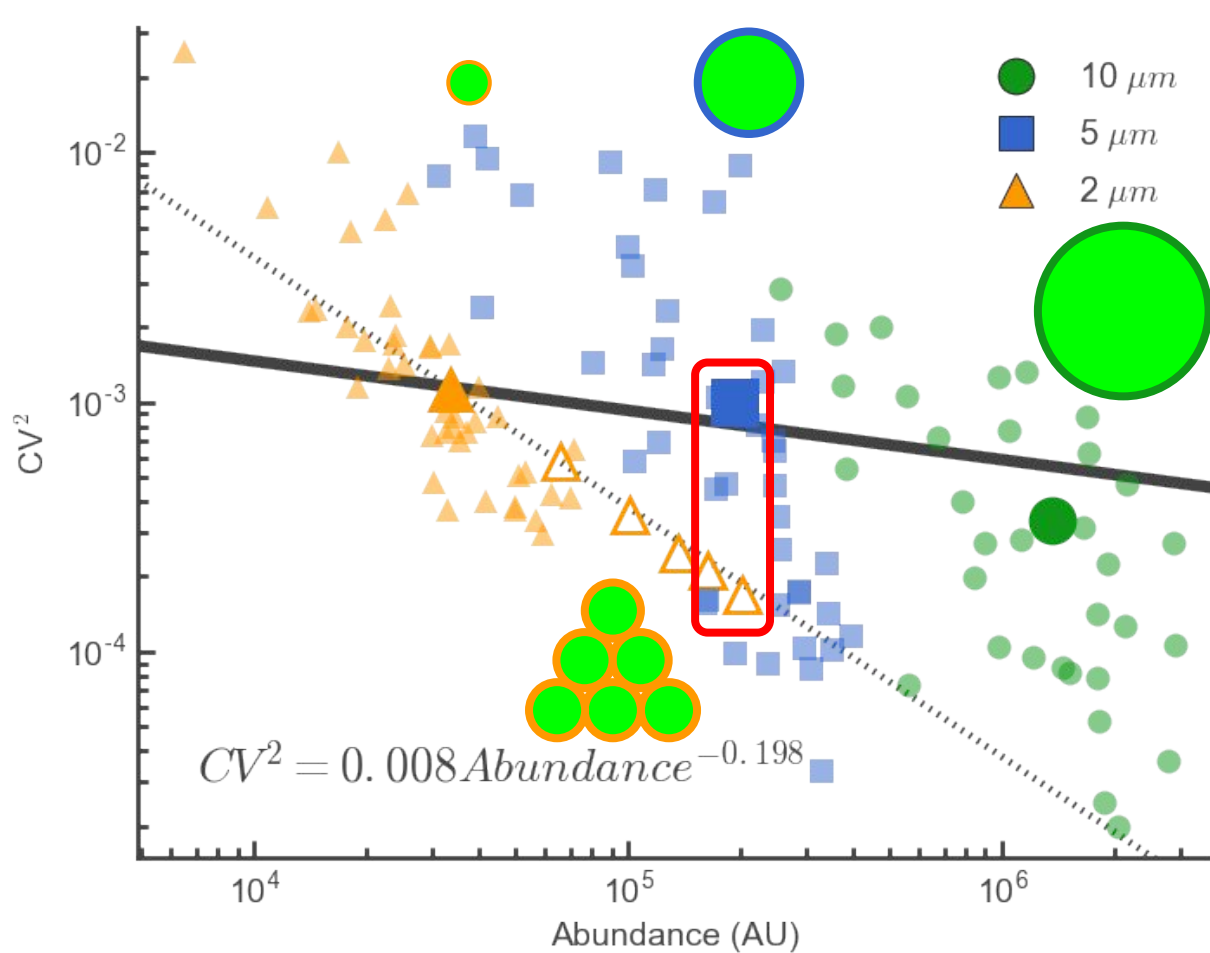

Burst frequency variation of expression centers

Low

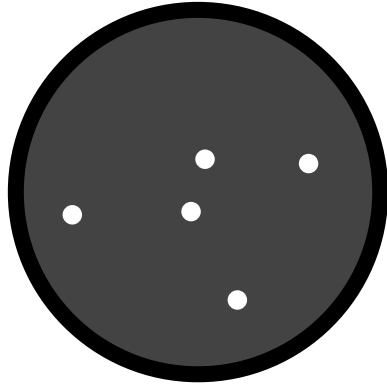

High

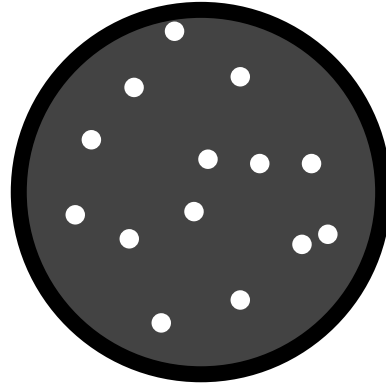

Burst size variation of expression centers

Low

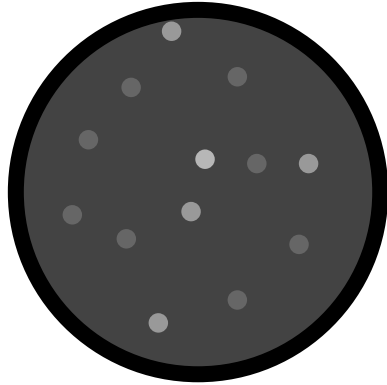

High

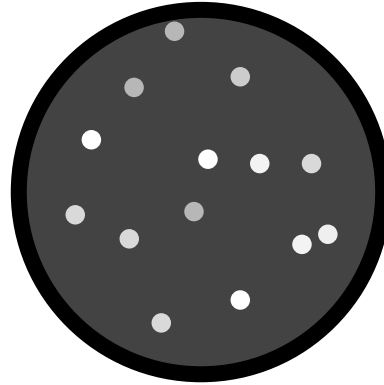

Cooperativity in resource allocation reinforces large bursts instead of creating new bursts

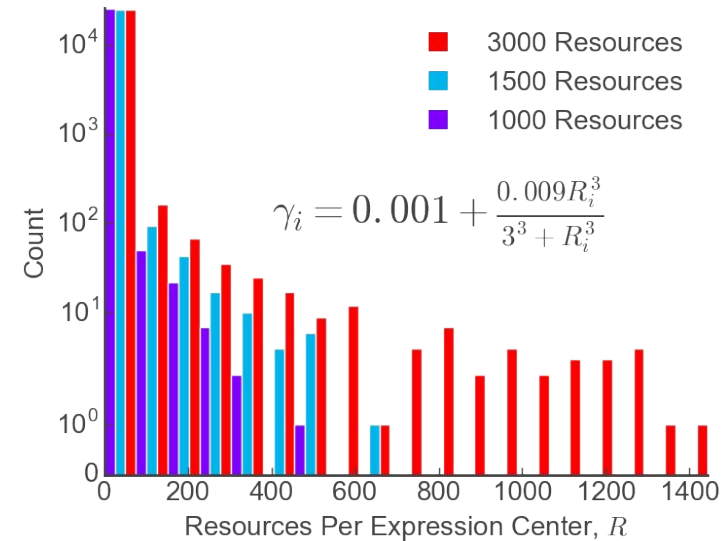
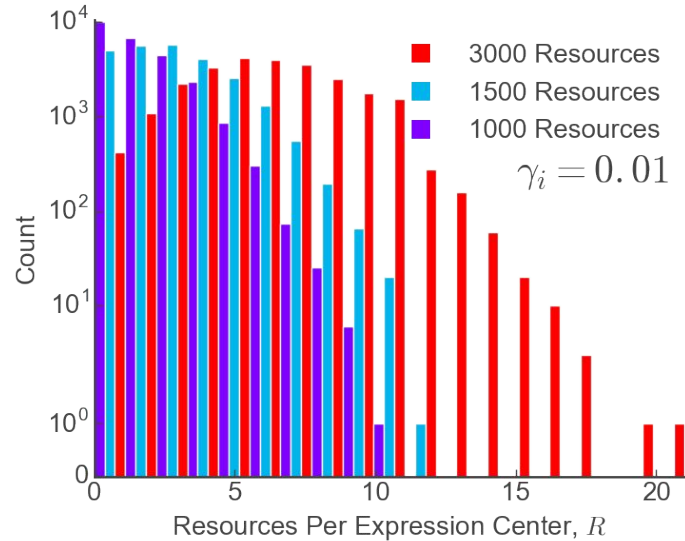
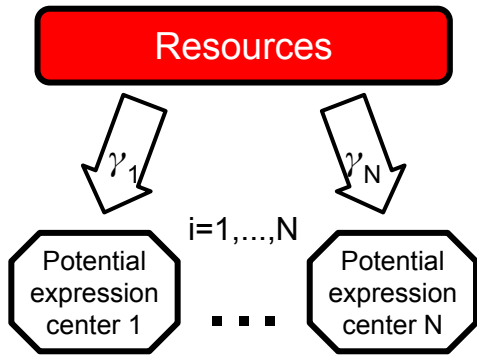

Summary Chapter 2

- Larger shared resource pools result in larger burst size but relatively constant burst frequency
- Larger divided resource pools resulted in larger burst frequency but constant burst size
- Resources are added to existing bursts instead of nucleating new bursts

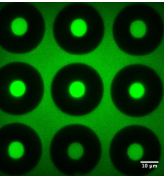
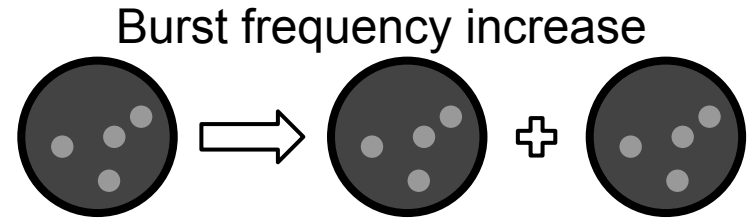
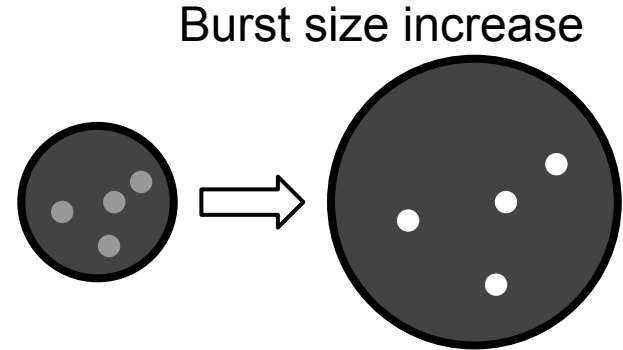

Outline

Chapter 1: Introduction

Chapter 2: Resource Sharing Controls Gene Expression Bursting

Chapter 3: Controlling Cell-Free Gene Expression Behavior by Tuning Membrane Transport Properties

Chapter 4: Conclusion

Chapter 3: Controlling Cell-Free Gene Expression Behavior by Tuning Membrane Transport Properties

A small fraction of vesicles are permeable to small, charged expression resources

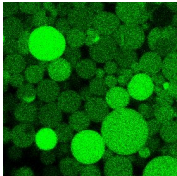
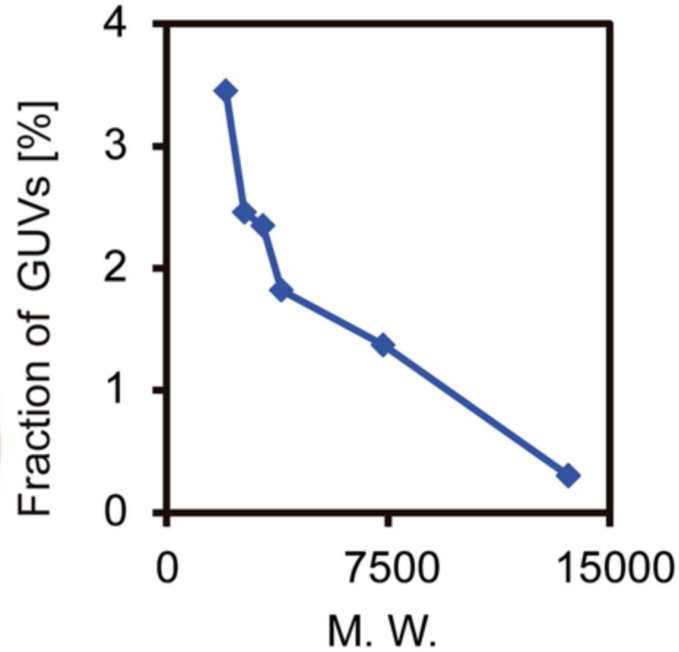
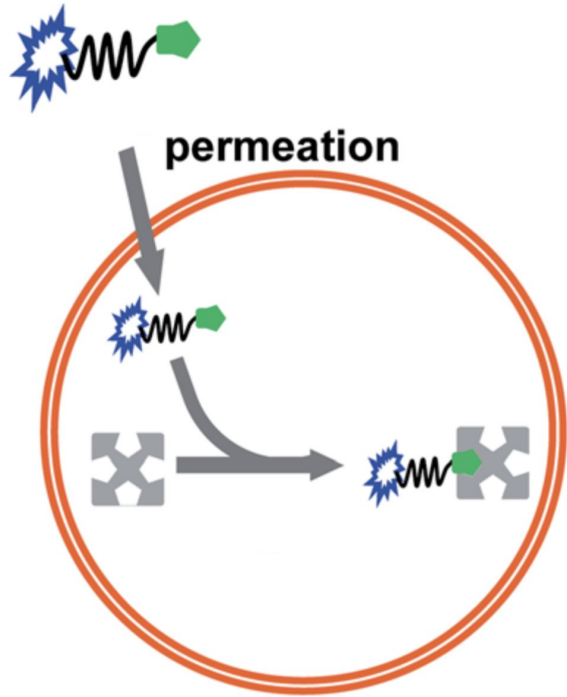

expression resources

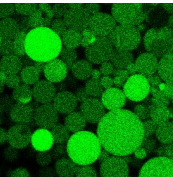
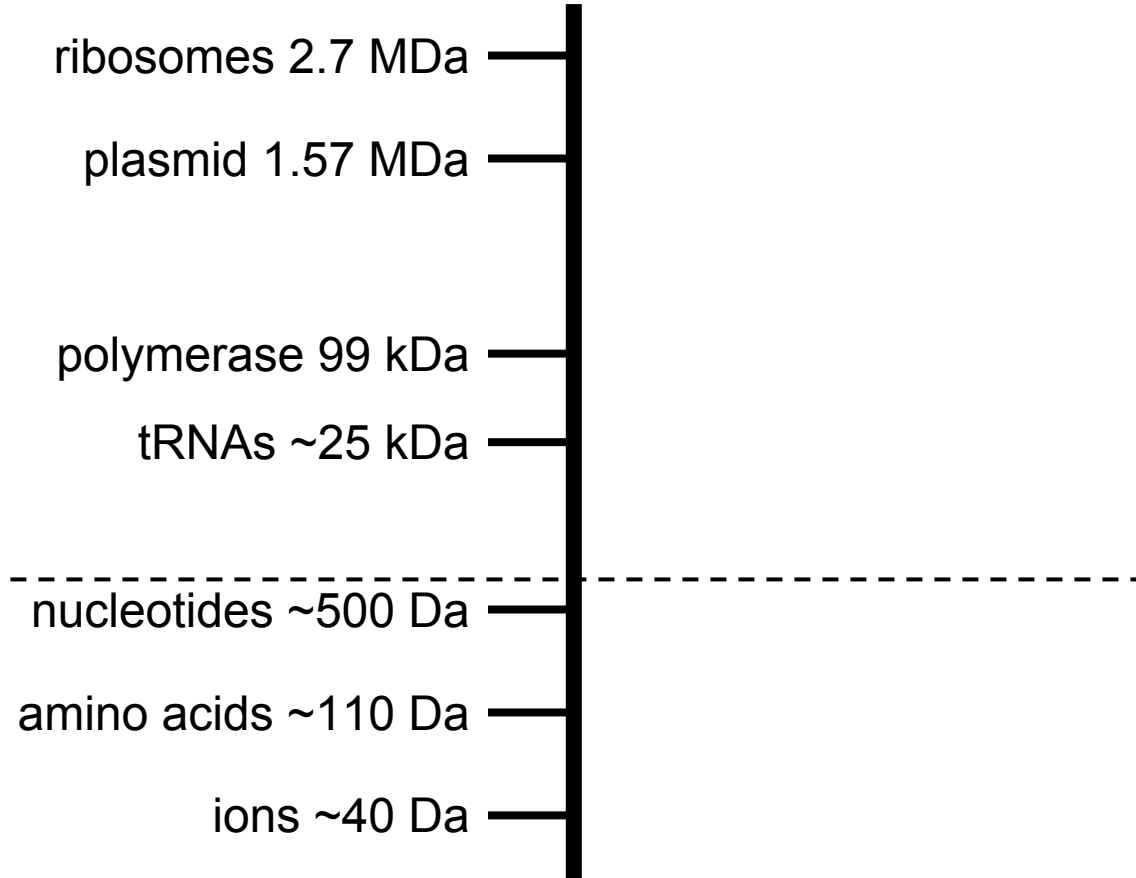

Few vesicles are permeable to expression resources

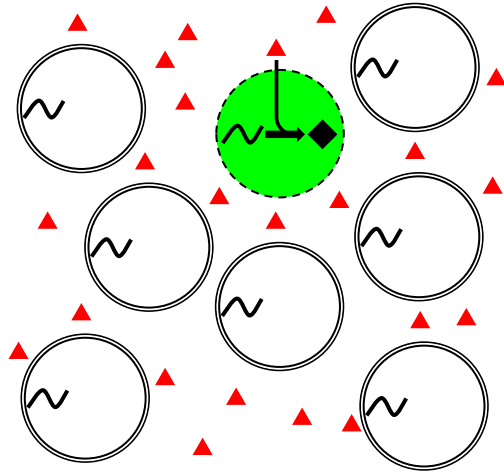

Can most vesicles be made permeable?

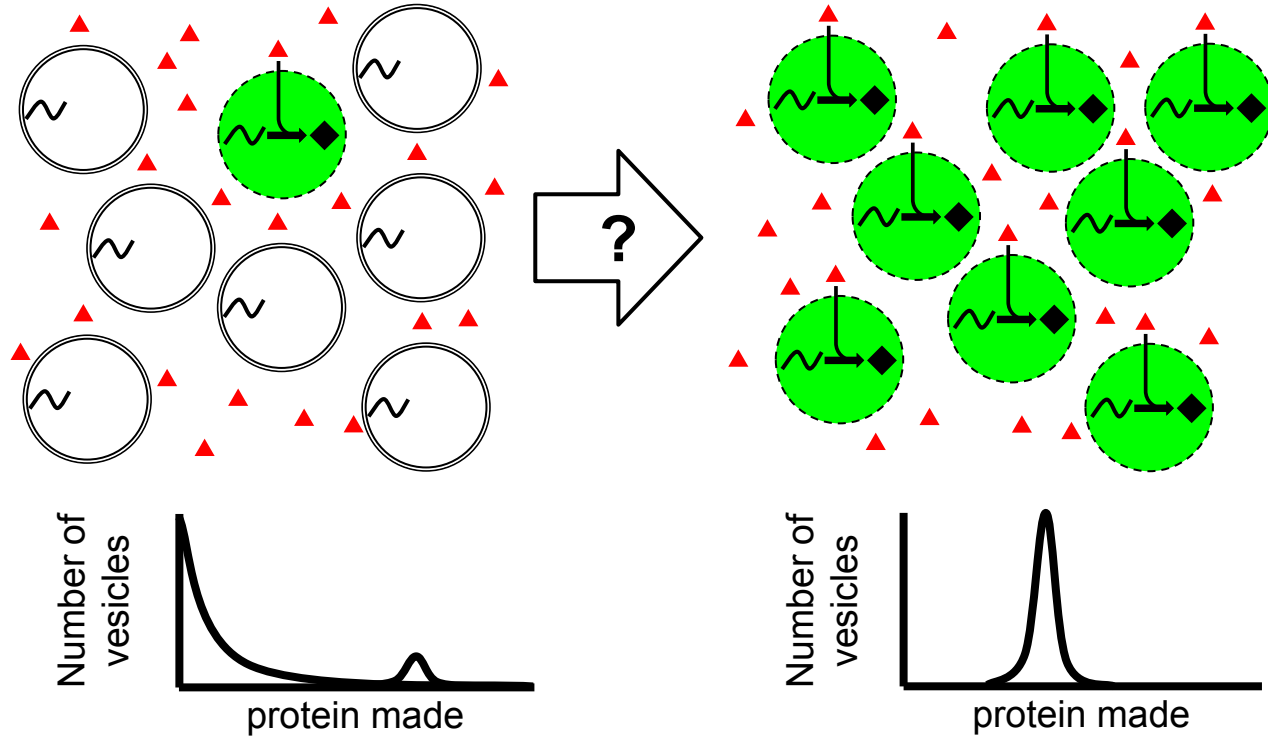

Photosensitized membrane have increased permeability

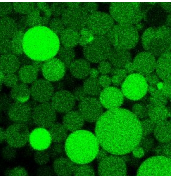
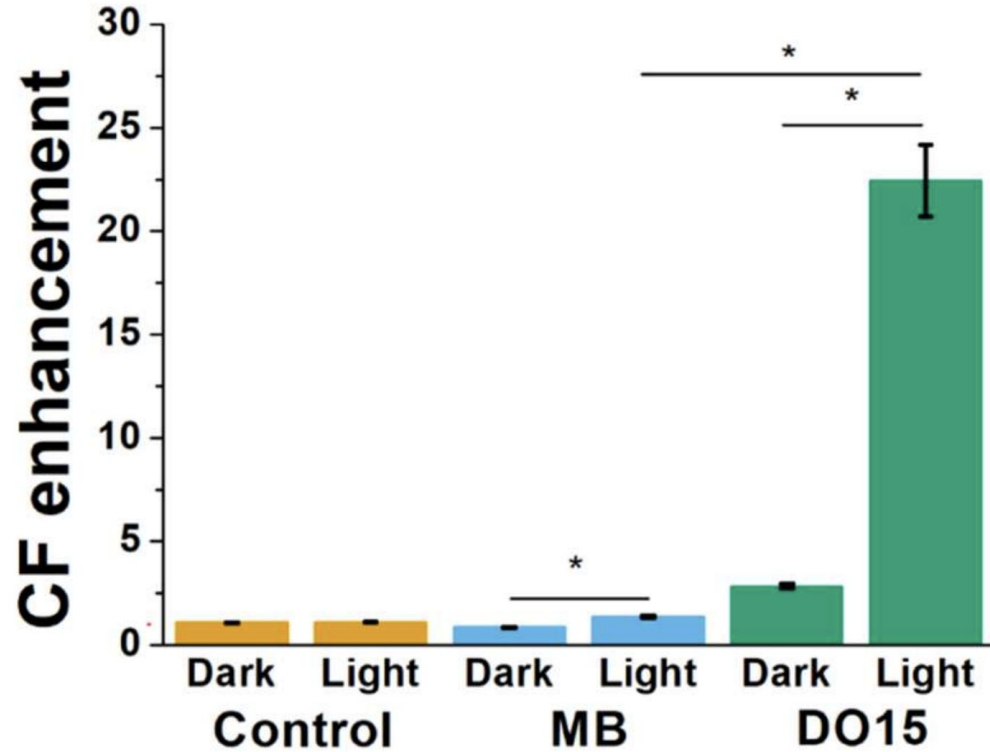

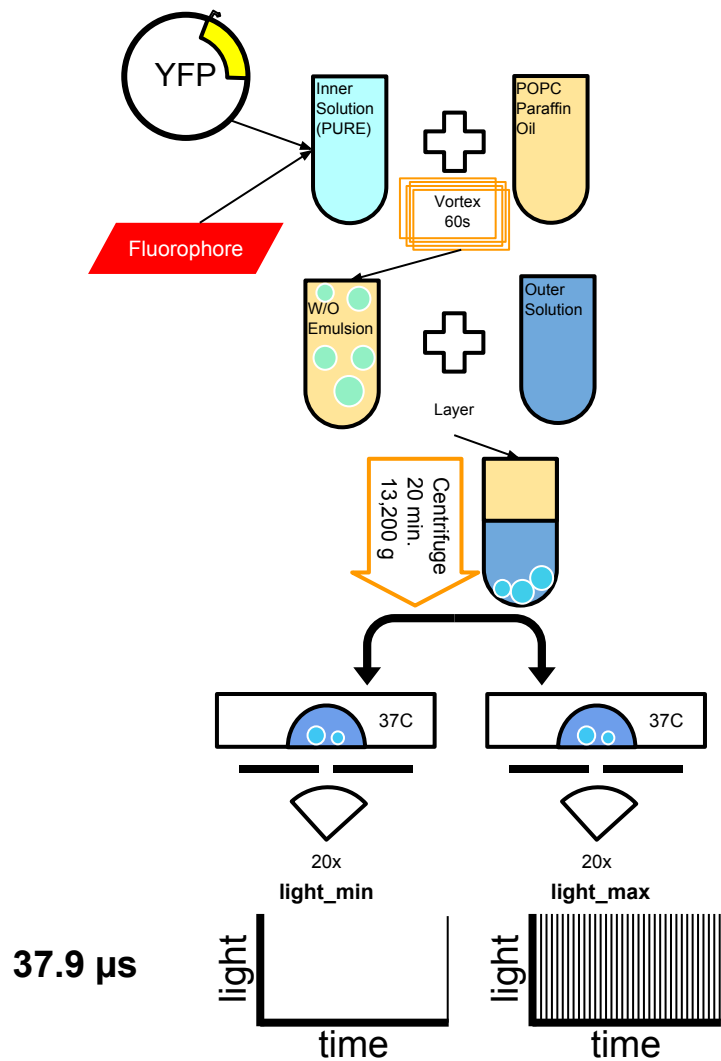

- Zeiss, LSM 710 confocal laser scanning microscope
- Z-stacks of ~23 slices were taken every 3 minutes for 2 hours
- slice was 512x512 pixels
- 405 nm, 6.5 mW; 488 nm, 6.1 mW; and 633 nm, 1.67 mW lasers
- Pixel = **0.81 μ m x 0.81 μ m**
- Laser dwell time per pixel every three minutes **37.9 μ s**

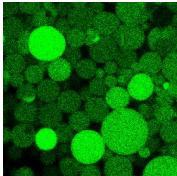

Volume marker

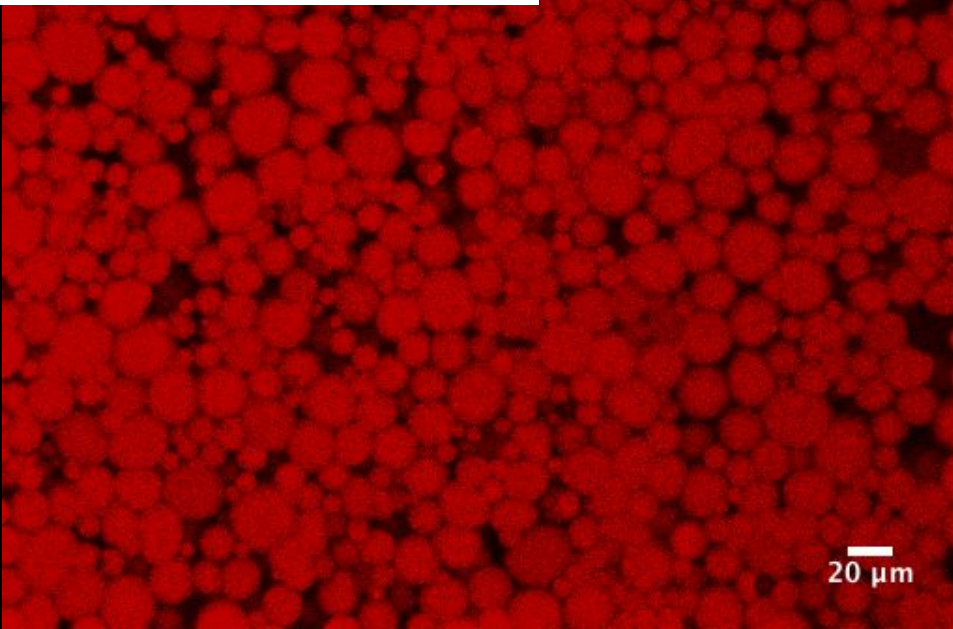
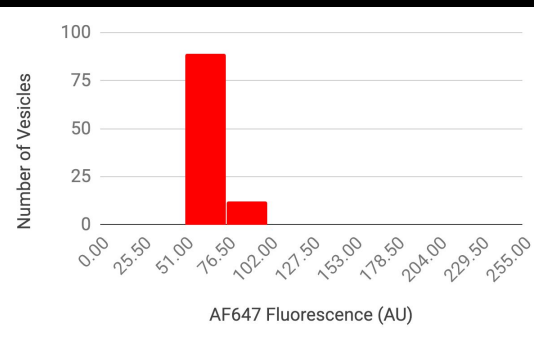

YFP Fluorescence

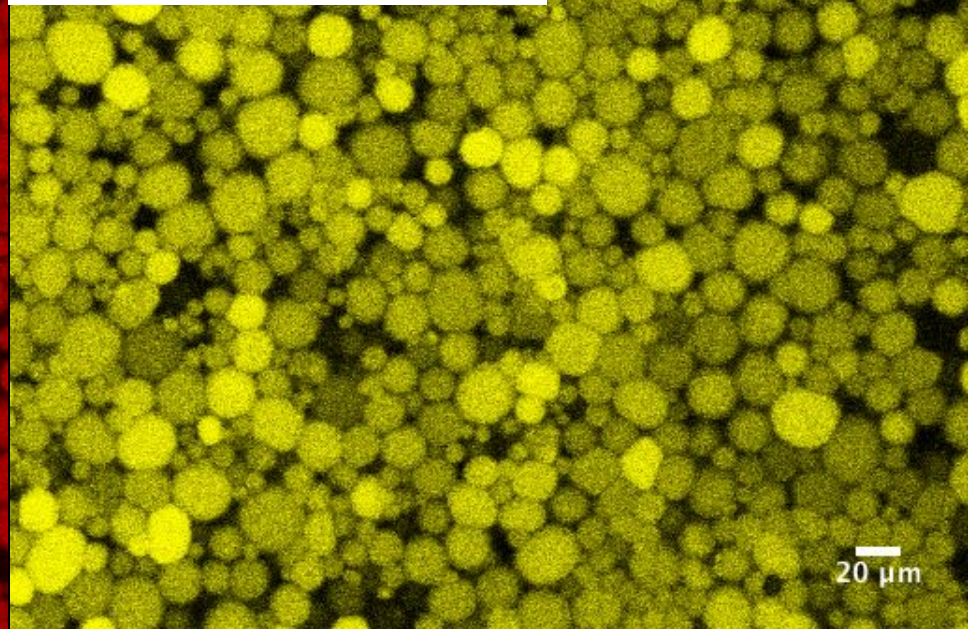
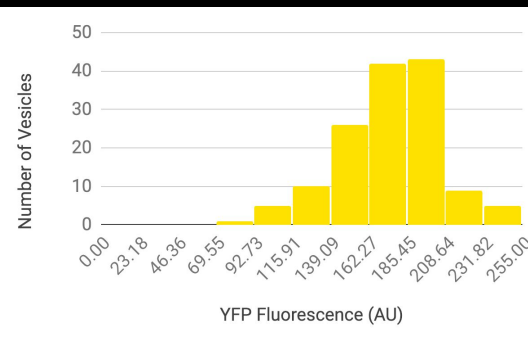

light_min

light_max

Volume marker

20 μm

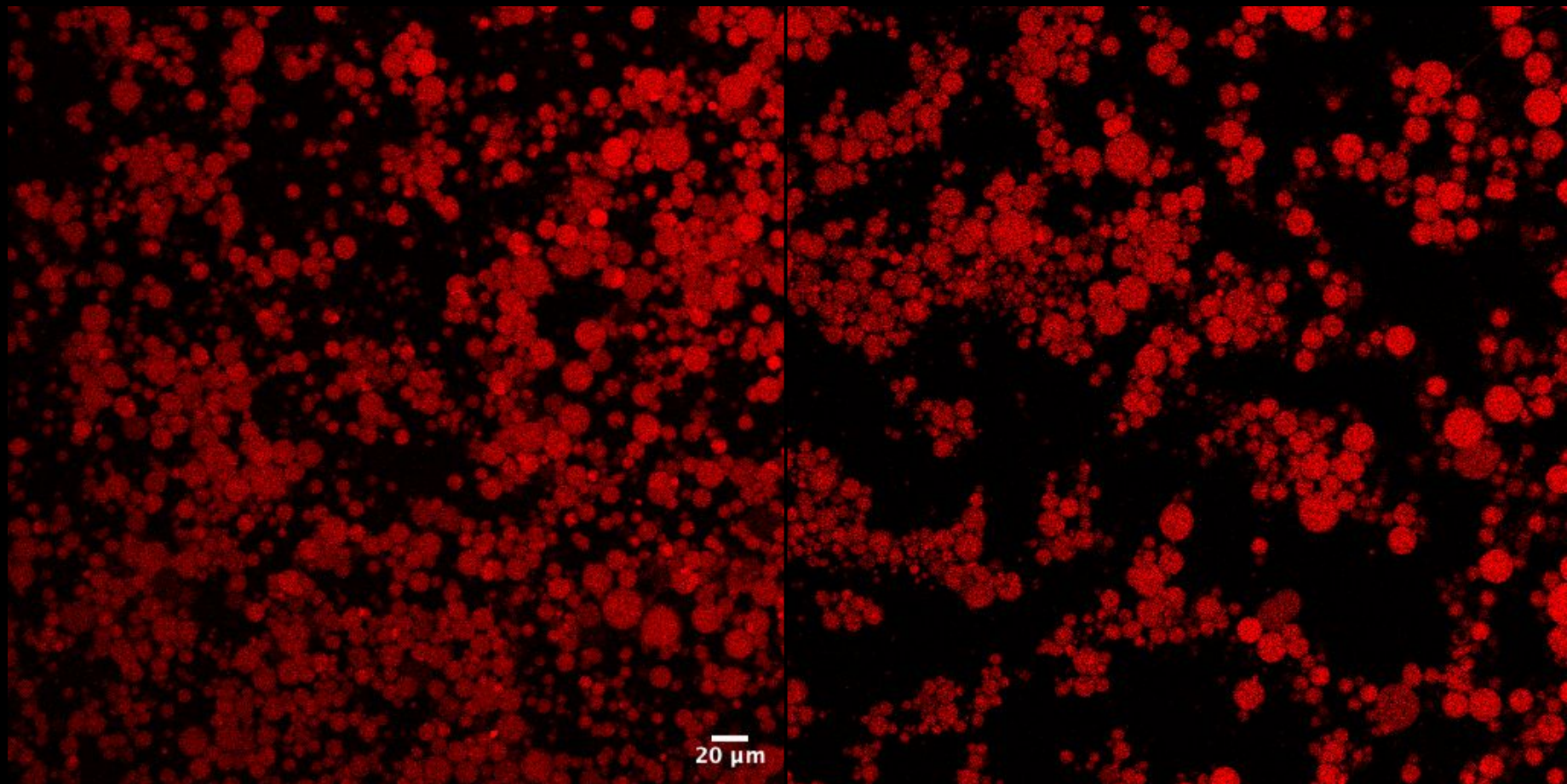

light_min

light_max

YFP Fluorescence

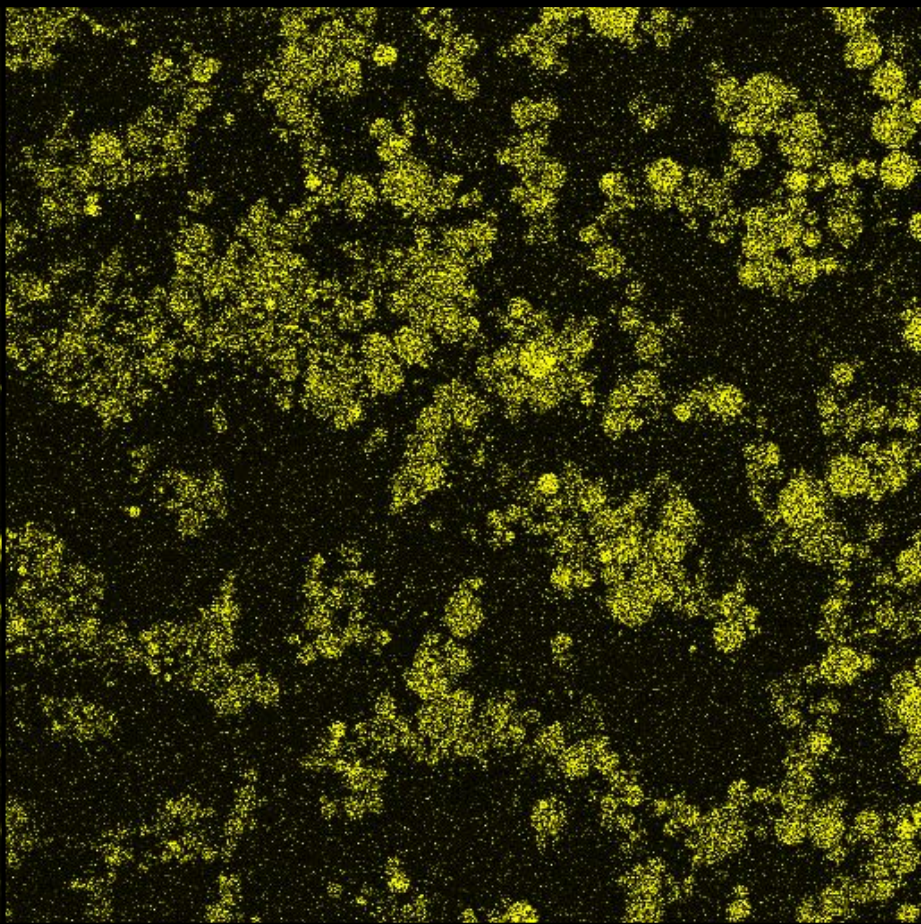
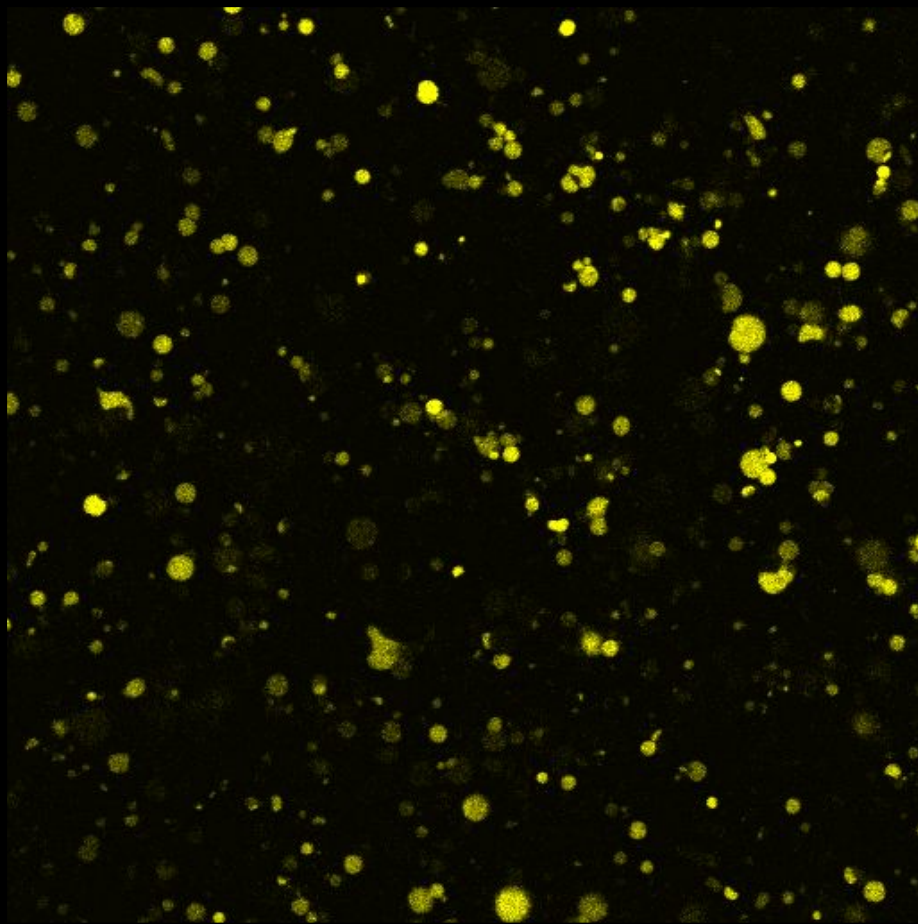

Photobleaching accounts for the decrease in the the AF647 signal

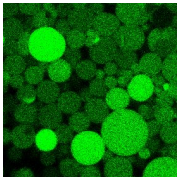
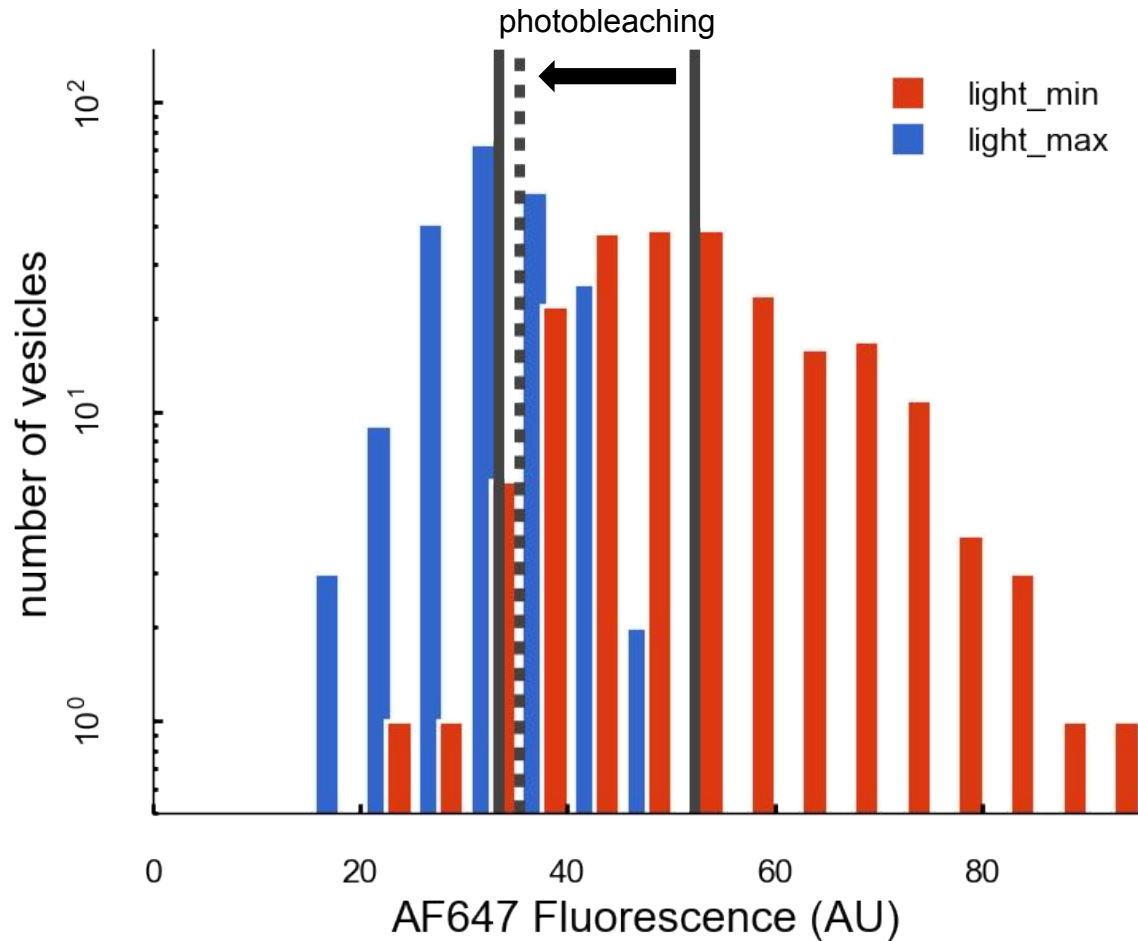

Light_max increases the mean and decreases the variability of protein expression

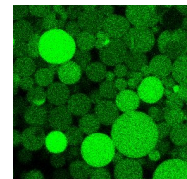
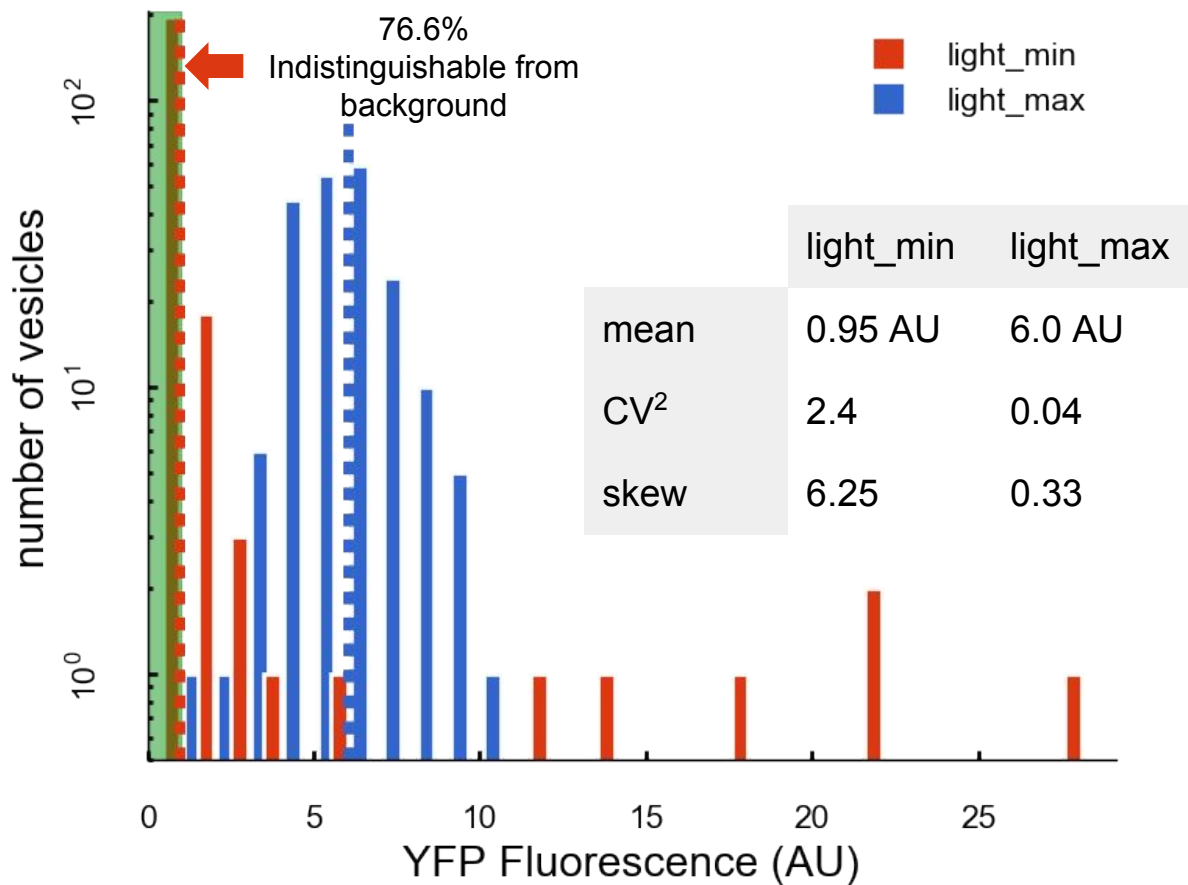

Well formed POPC
membrane

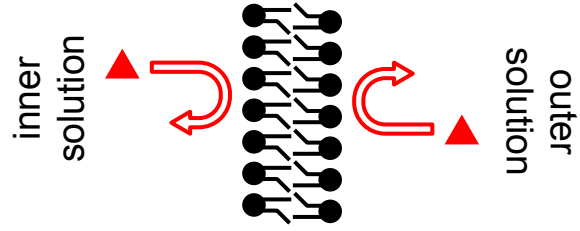

Singlet oxygen reacts with POPC

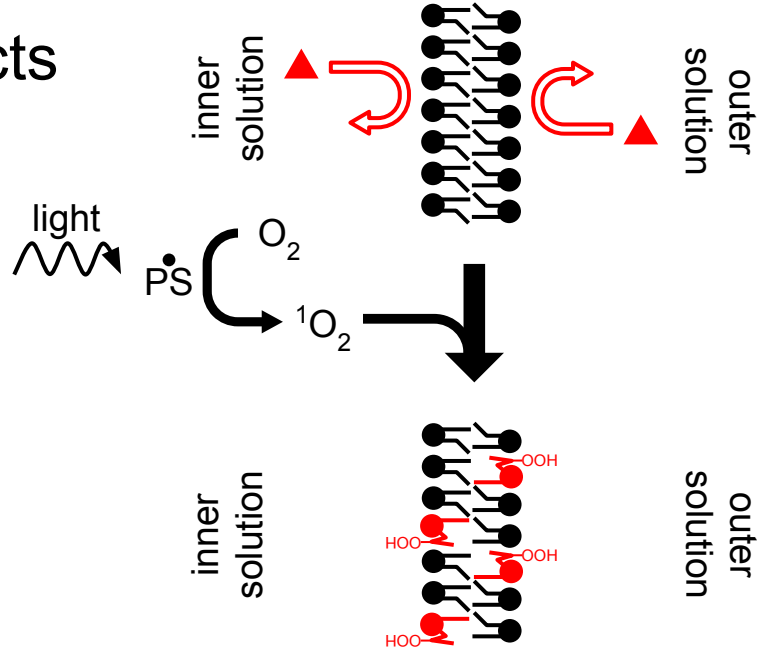

Bill McClintic and Dr. C. Patrick Collier

Itri, R., Junqueira, H. C., Mertins, O., & Baptista, M. S. (2014)

POPC molecules with aldehyde capped tails lead to pores

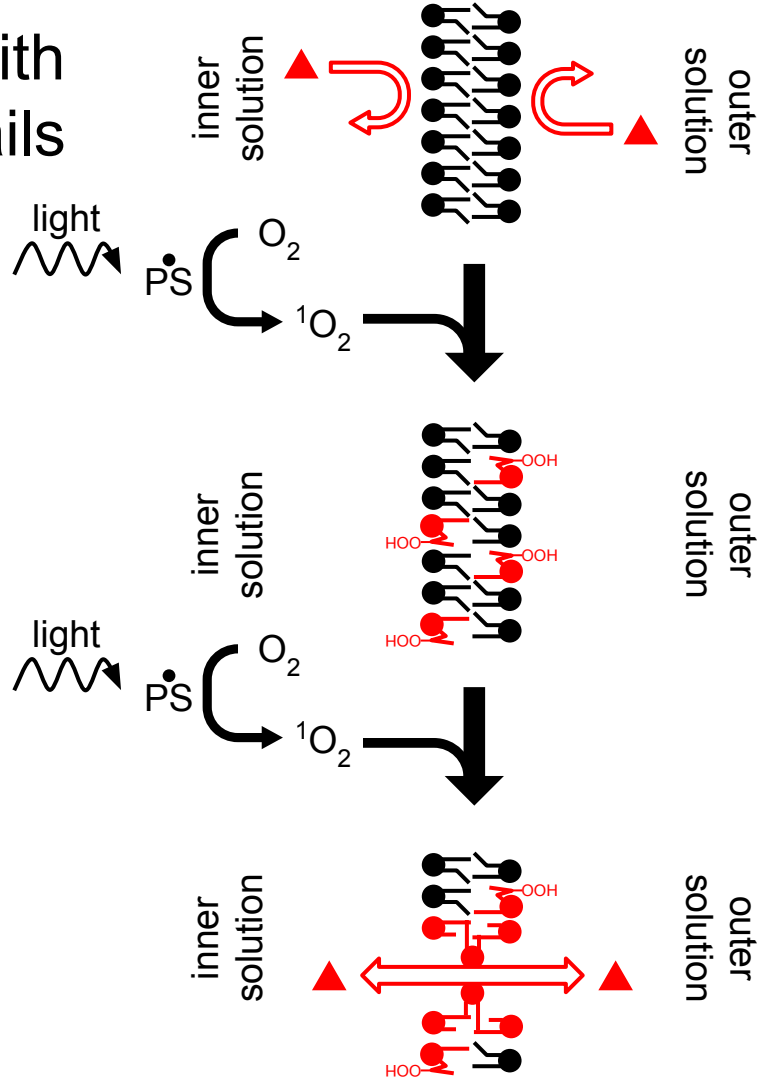

Bill McClintic and Dr. C. Patrick Collier

Itri, R., Junqueira, H. C., Mertins, O., & Baptista, M. S. (2014)

expression resources

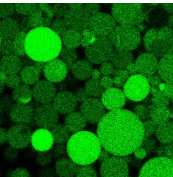
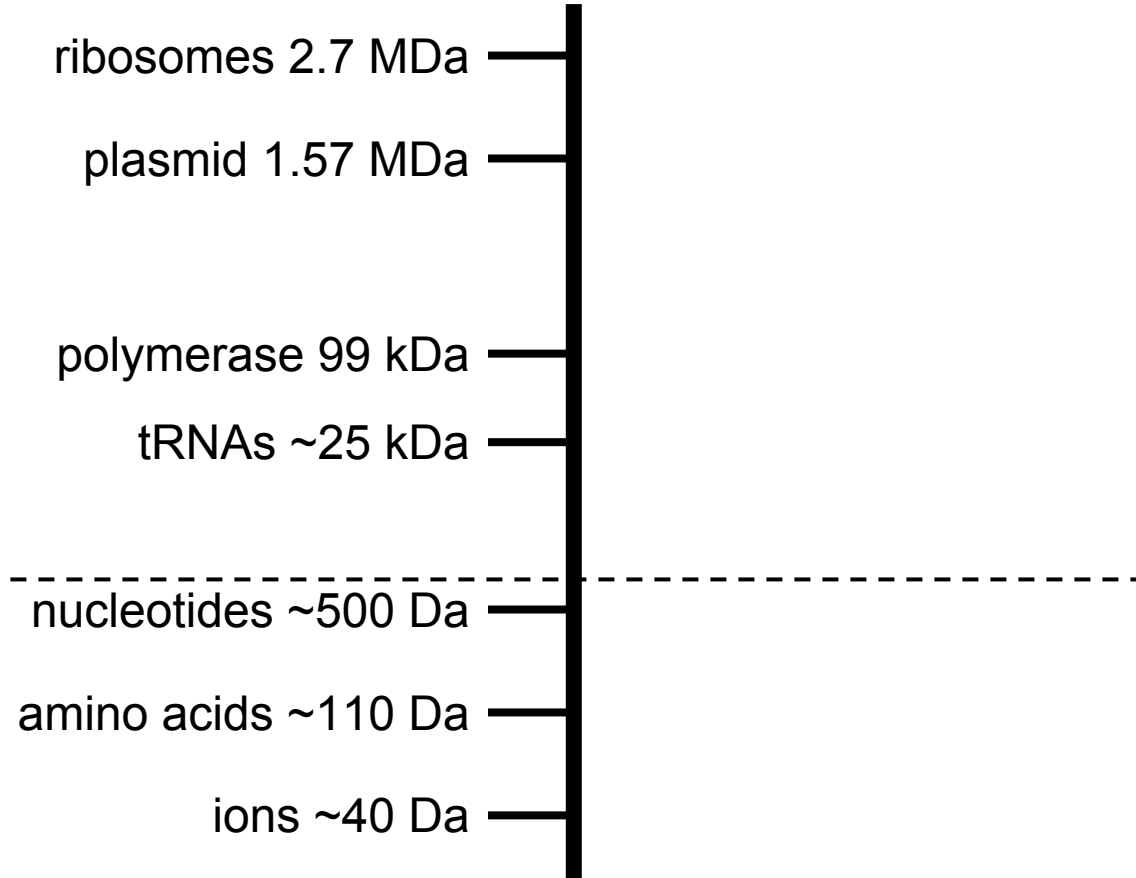

expression resources fluorophores

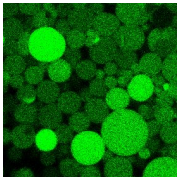
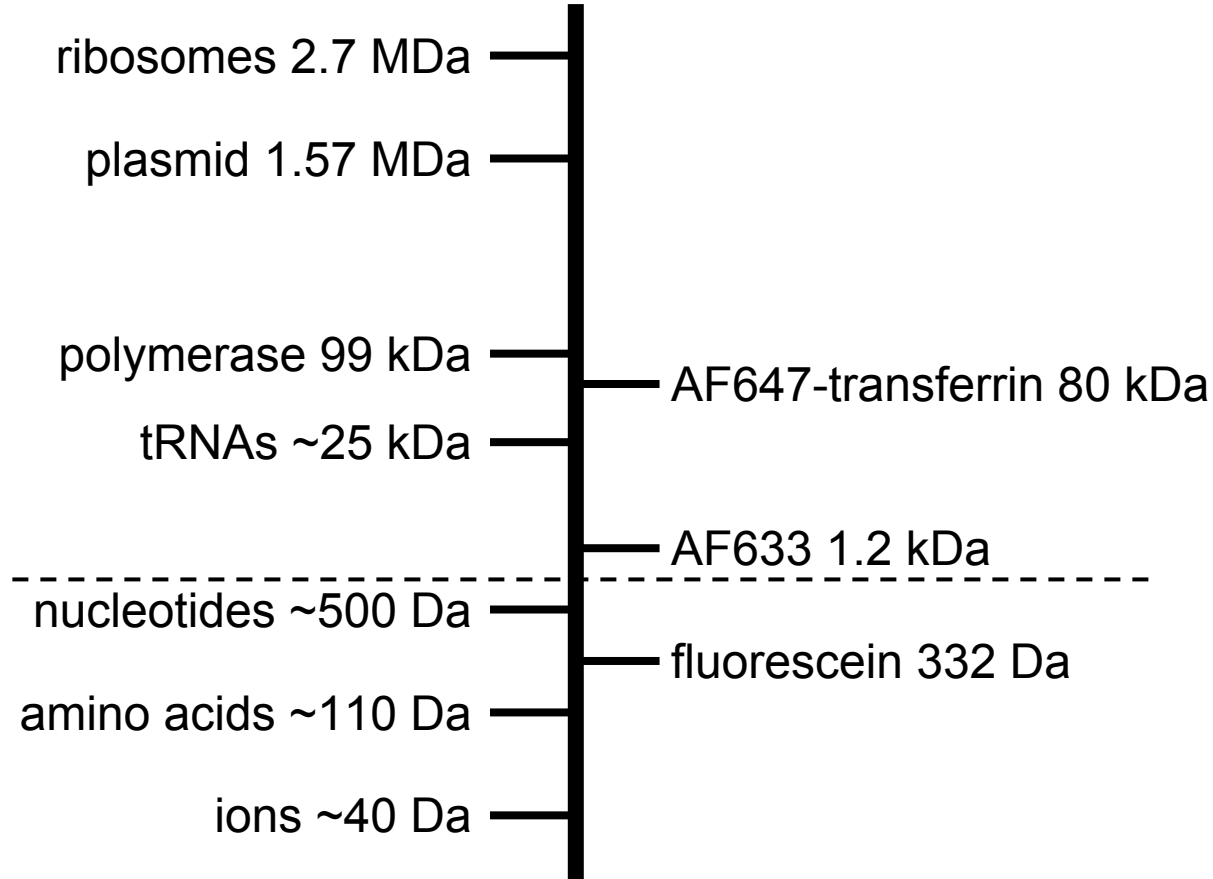

Fluorescein

AF633

AF647-transferrin

A

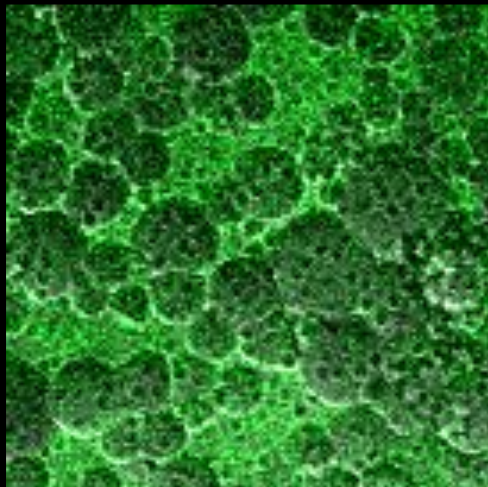

B

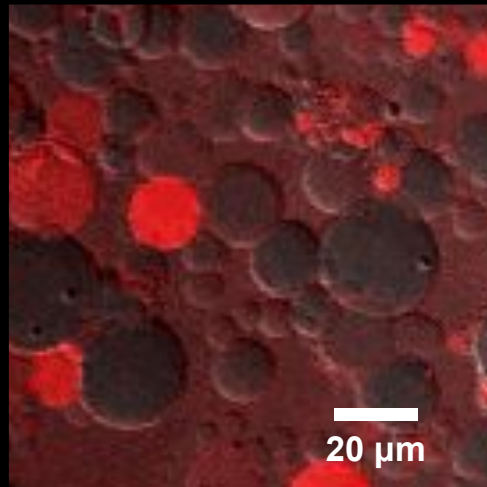

C

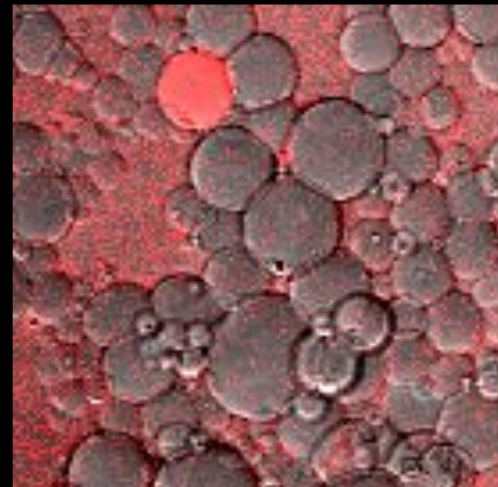

D

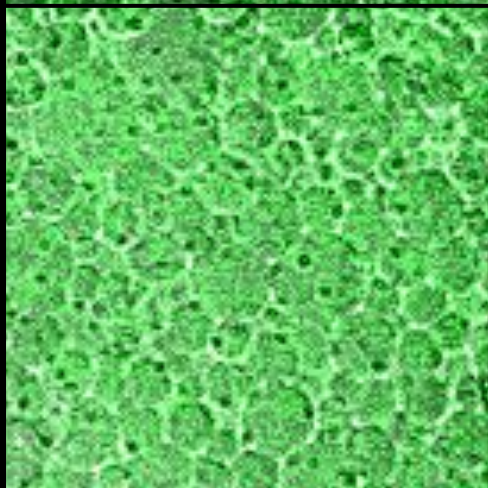

E

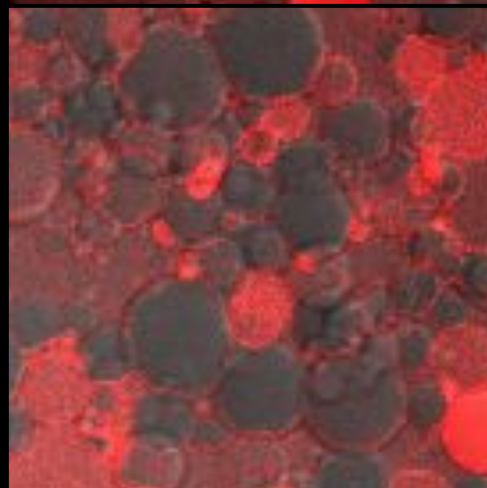

F

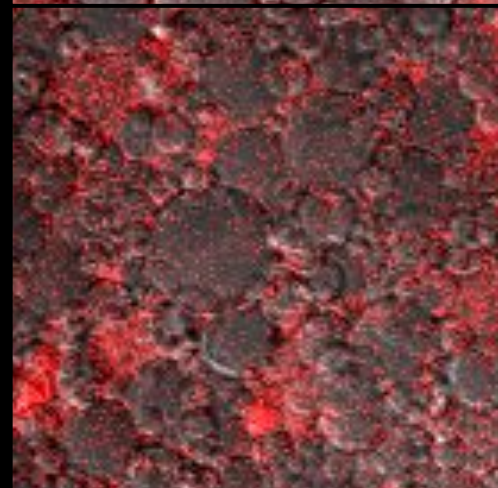

light_min

light_max

Small molecules cross permeabilized membranes while large molecules do not

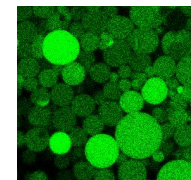
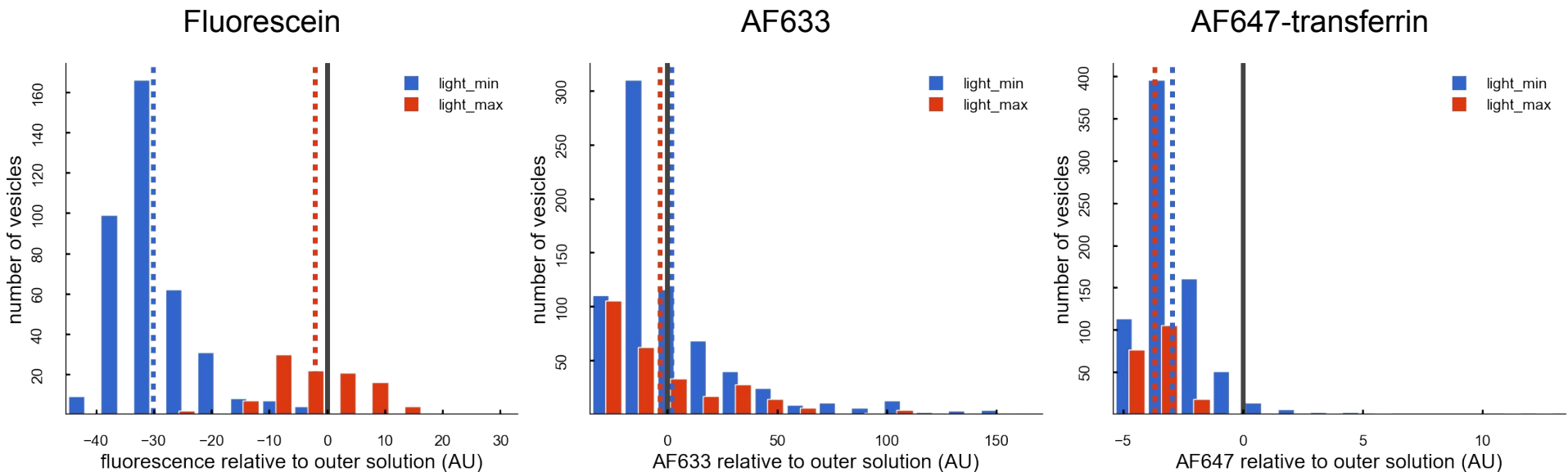

expression resources fluorophores

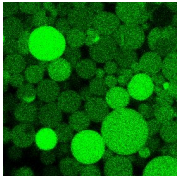
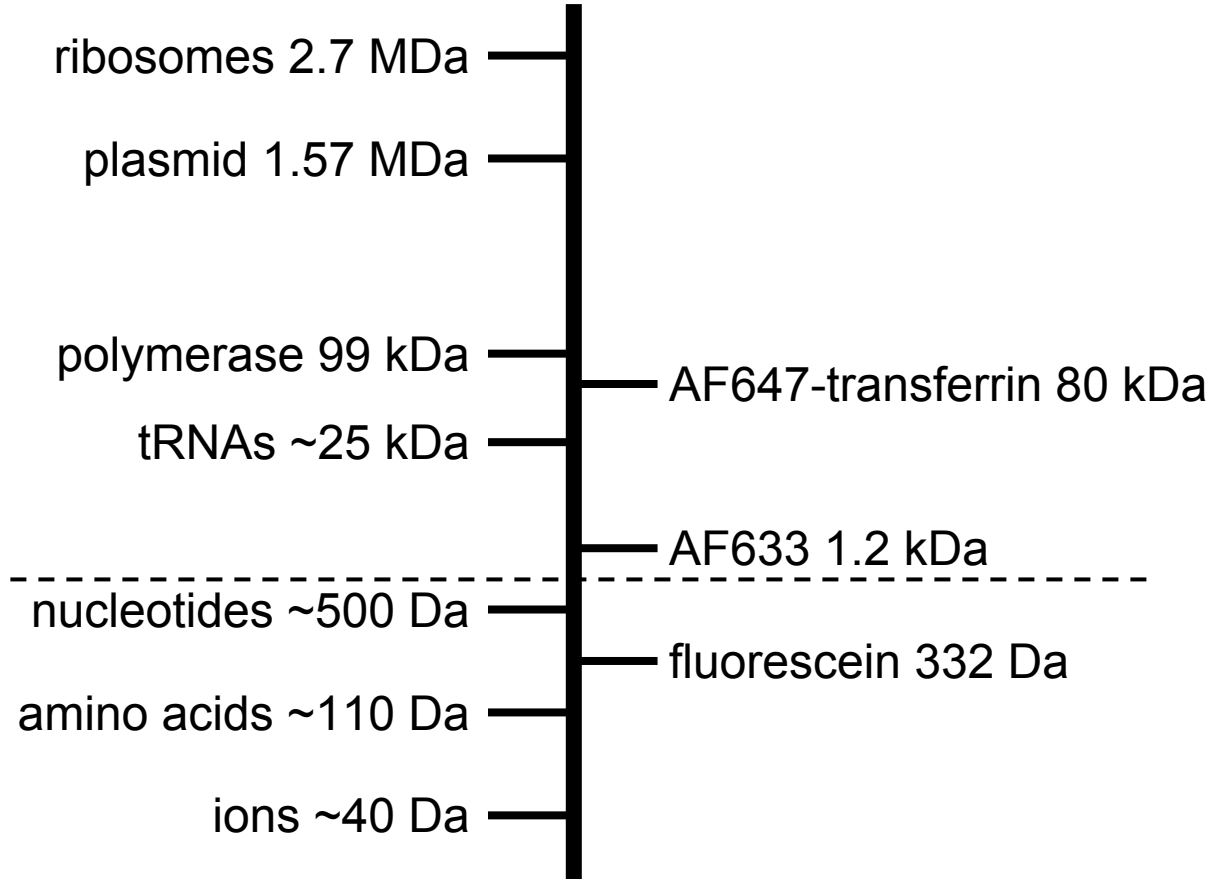

How does membrane permeability change during light_max?

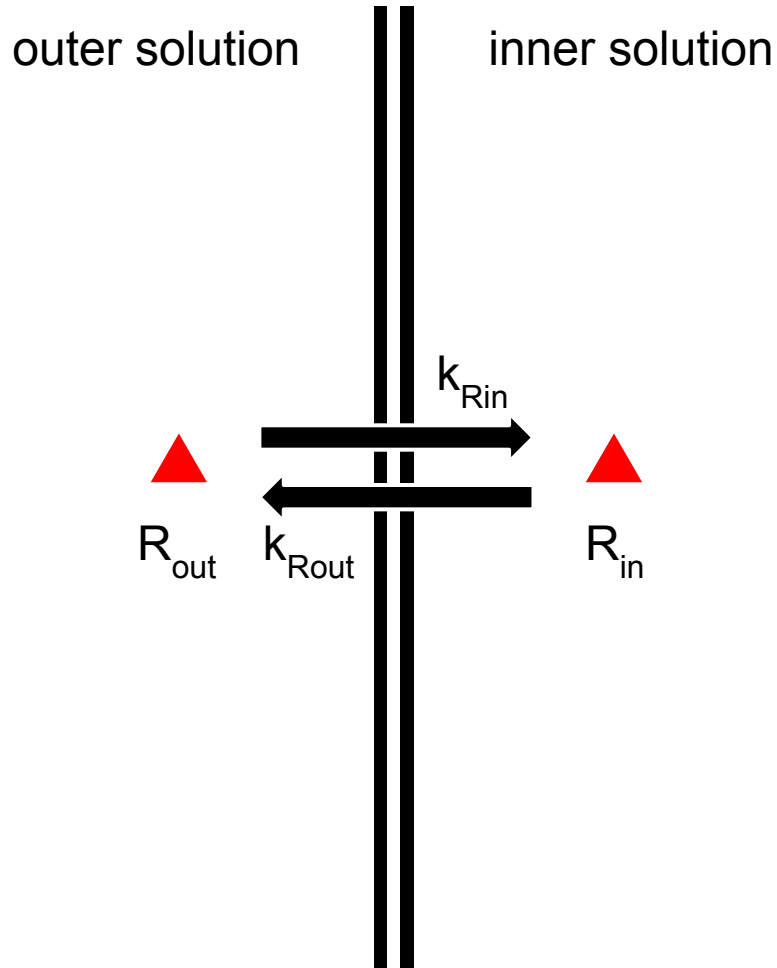

$$\frac{d[R_{in}]}{dt} = k * [R_{out}] - k * [R_{in}]$$

Membrane permeabilization increases linearly with time

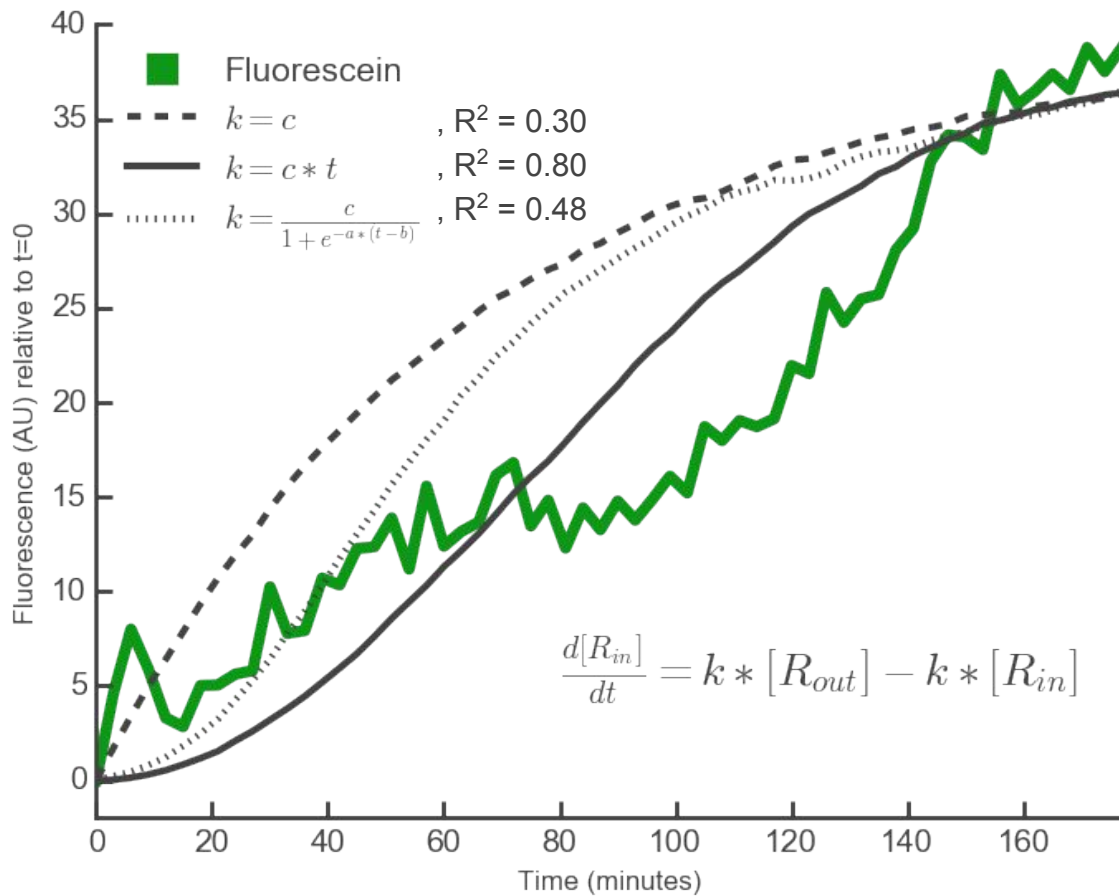
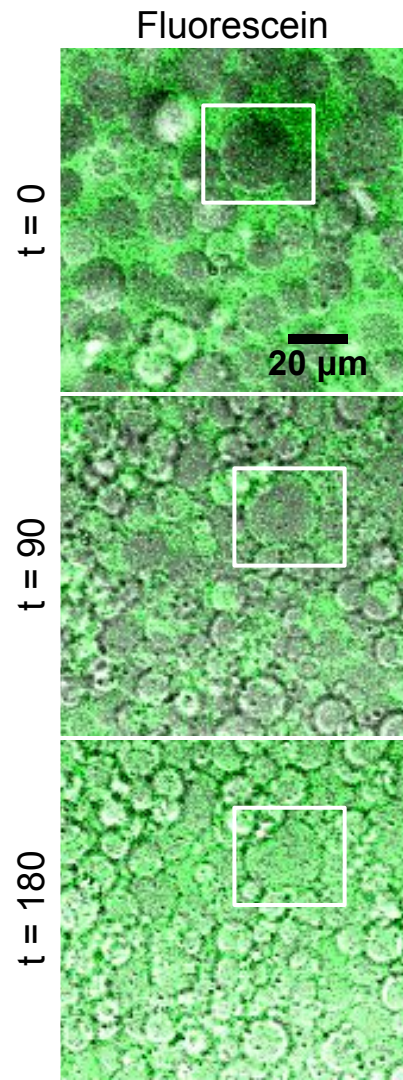

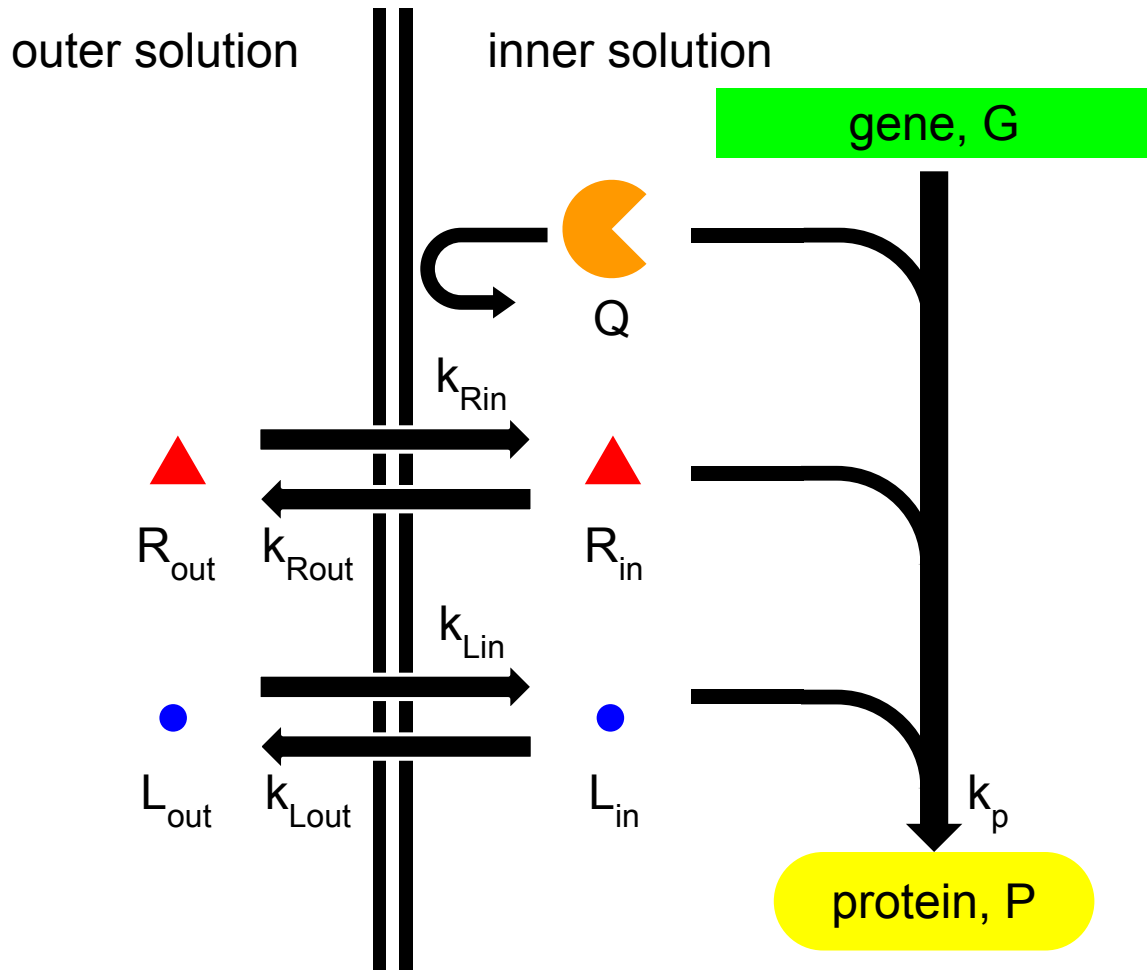

Protein expression dependent upon both encapsulated and outer resources

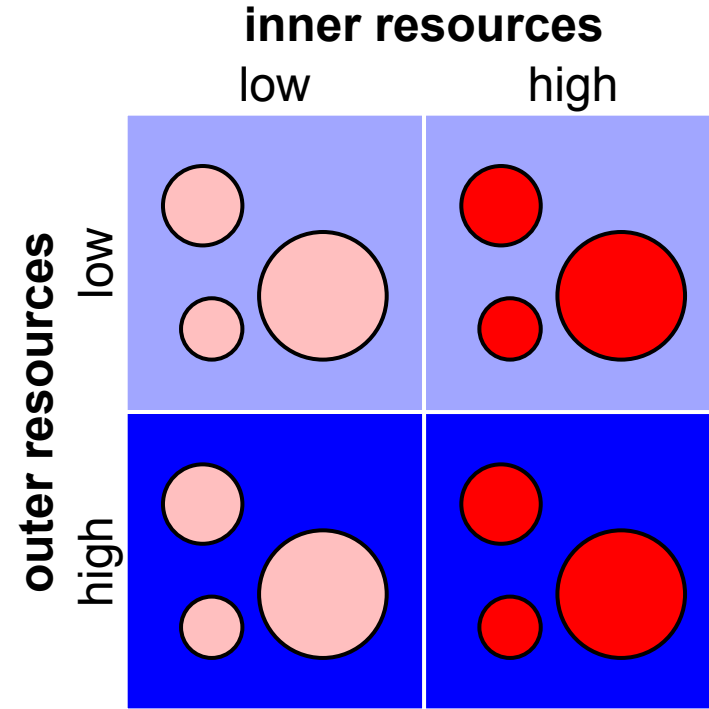

Membrane permeabilization results in a lag in expression

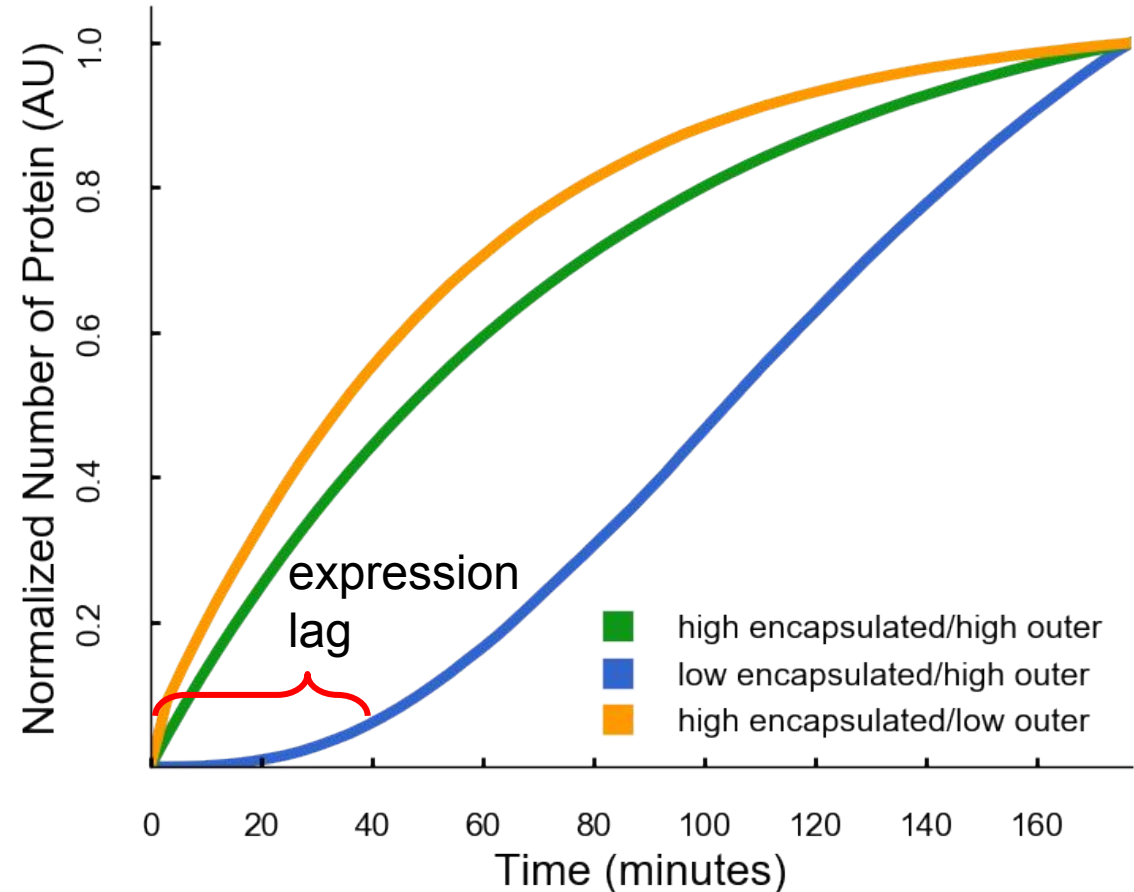

Resource transport delays protein expression

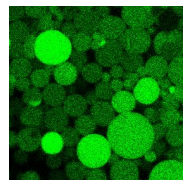
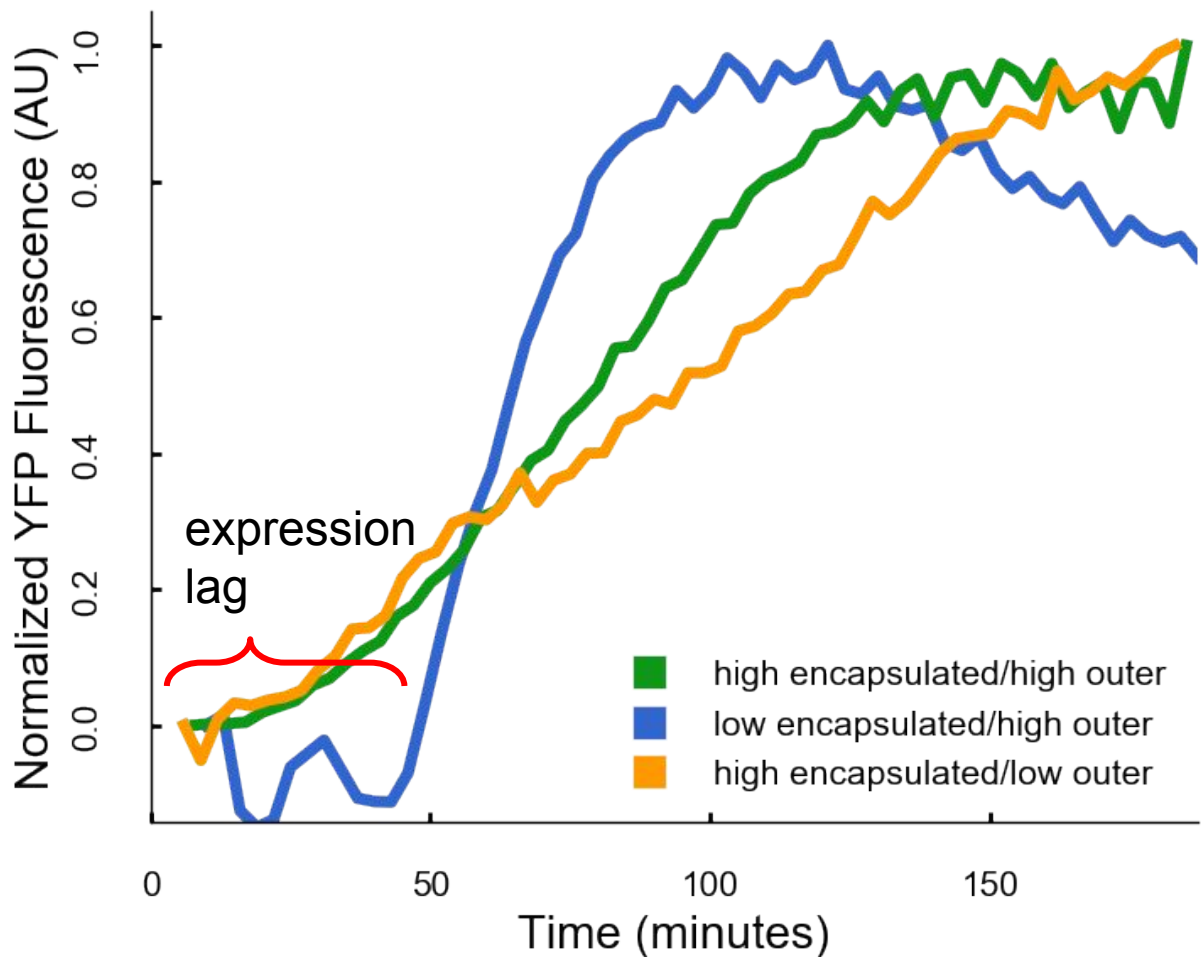

Model predicts greatly reduced mean protein

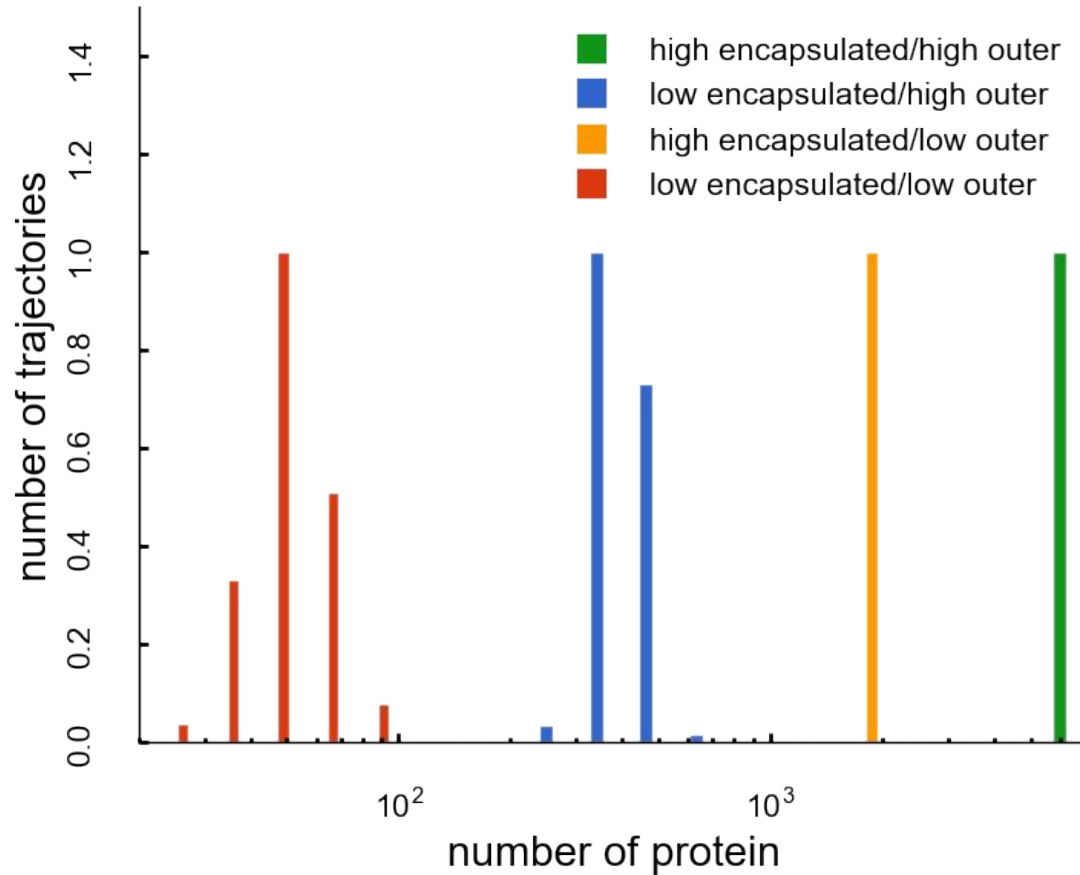

low encapsulated

high encapsulated

A

B

lower outer

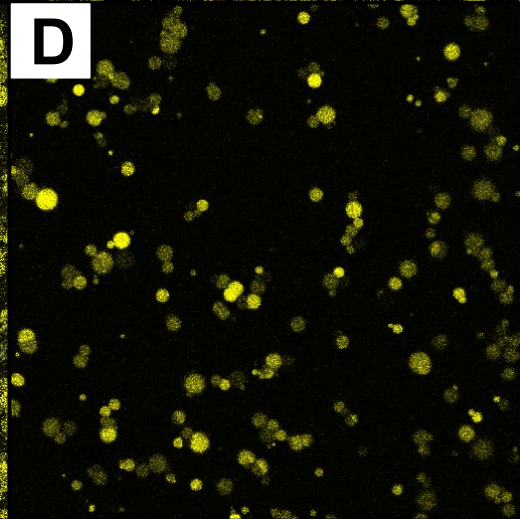
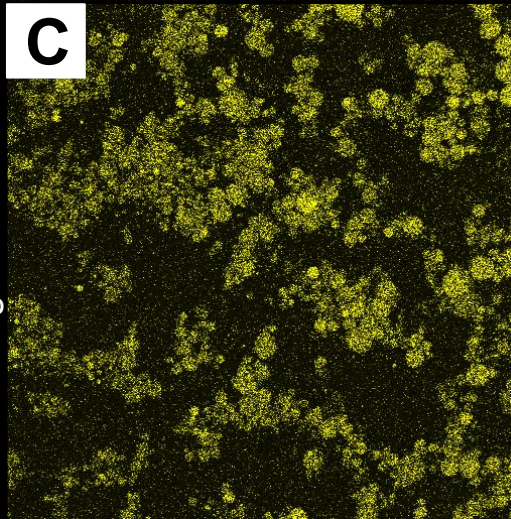
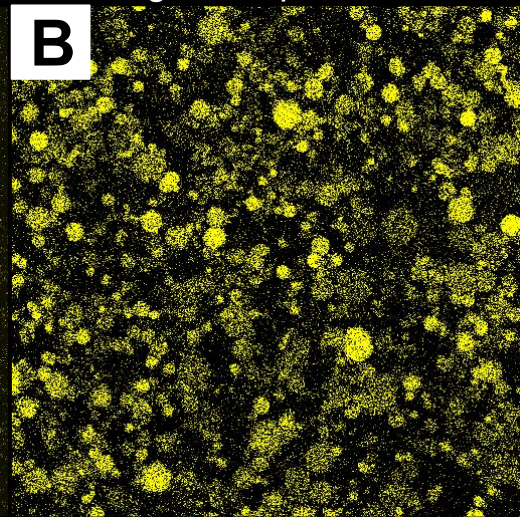
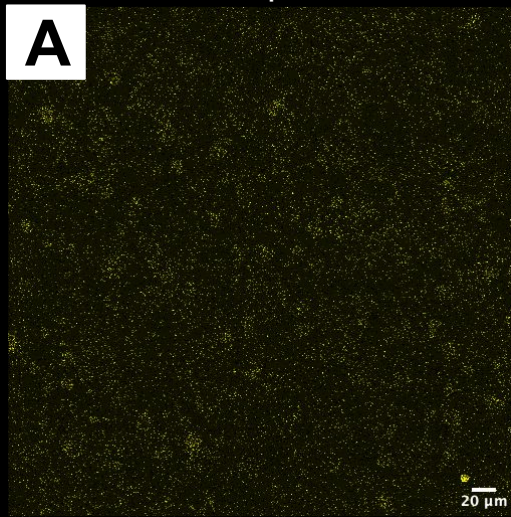

C

D

high outer

20 μm

Resource concentrations control mean protein

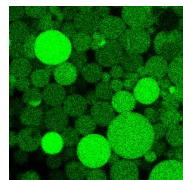
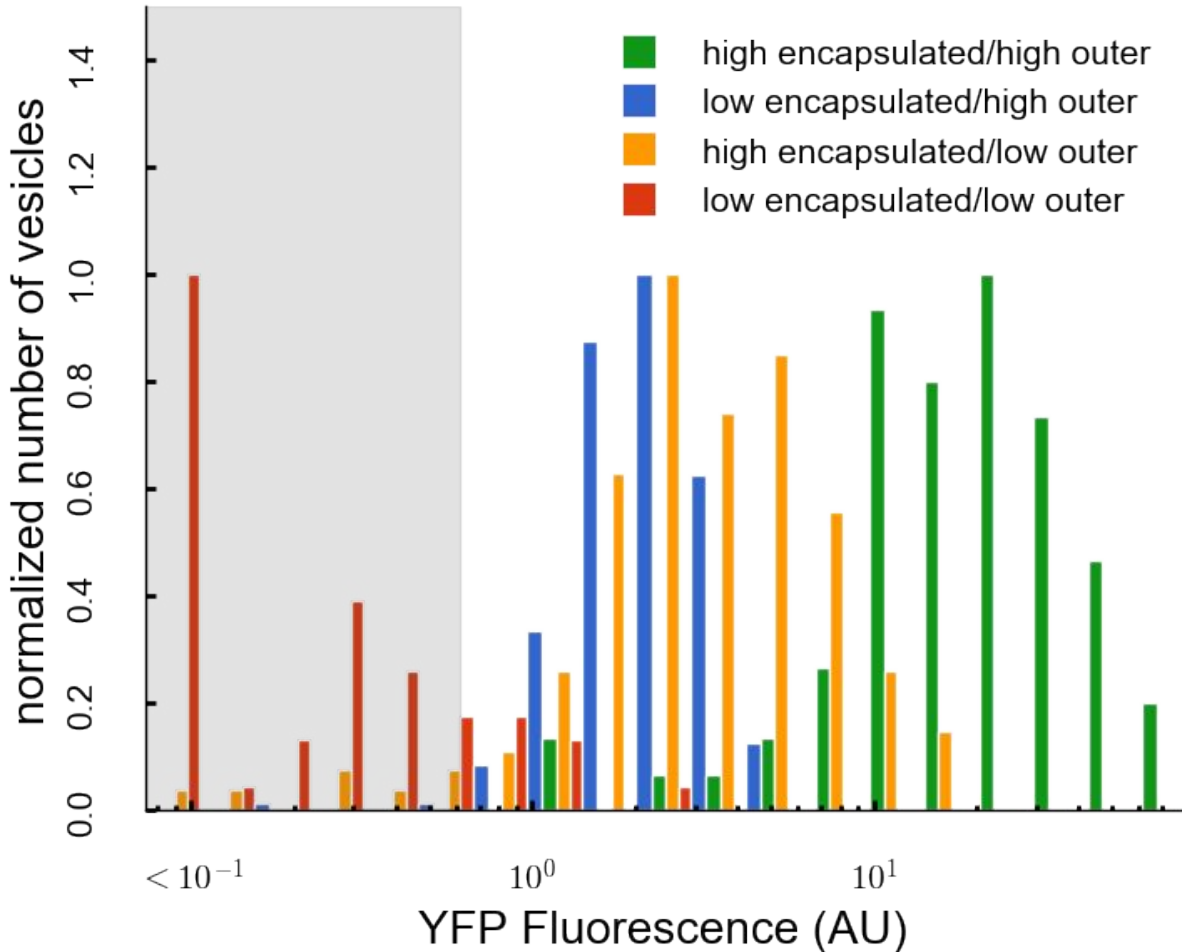

Chapter 3 Summary

1. Small resources cross permeabilized membranes
2. Photo-treatment can increase protein expression in vesicles.
3. Photo-treatment makes protein expression more uniform.
4. Resource transport across the membrane delays protein expression

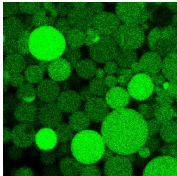
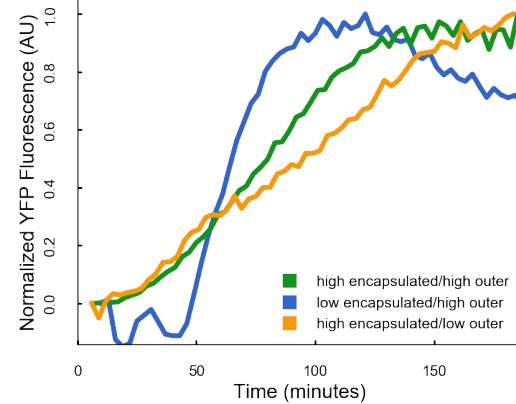
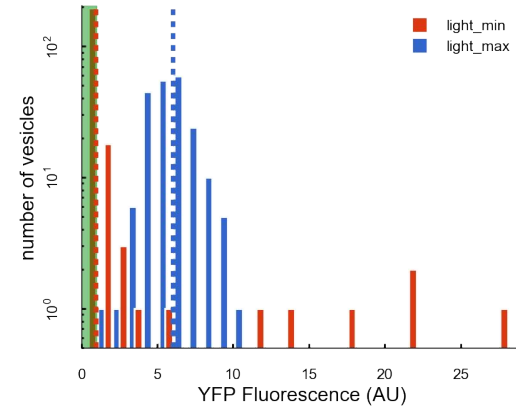

Outline

Chapter 1: Introduction

Chapter 2: Resource Sharing Controls Gene Expression Bursting

Chapter 3: Controlling Cell-Free Gene Expression Behavior by Tuning Membrane Transport Properties

Chapter 4: Conclusion

Chapter 4: Conclusion

Conclusions

1. Larger resource pools contribute to existing expression centers instead of nucleating new centers
2. Vesicle membranes can be made permeable to small expression resources
3. Permeabilized membranes result in higher average protein expression and more uniform expression
4. Membrane permeabilization delays protein expression

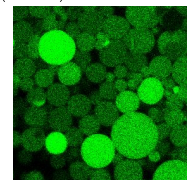
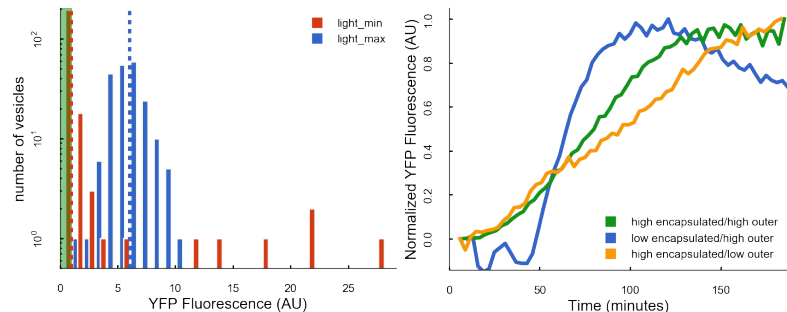
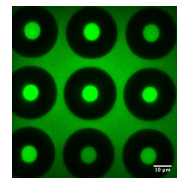
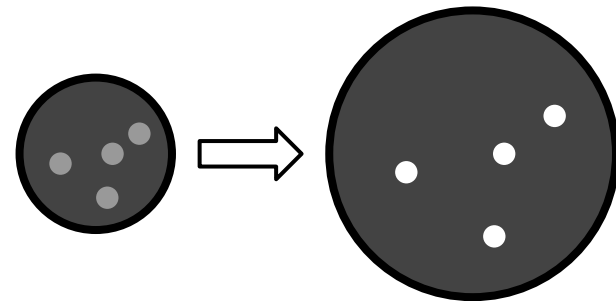

Acknowledgements

Dr. Michael Simpson

Dr. Mitchel Doktycz

Dr. Scott Retterer

Dr. Steven Abel

Dr. Eric Boder

Dr. C. Patrick Collier

Dr. Jenny Morrell-Falvey

Dr. Liz Norred

Dr. Charles Chin

Bill McClintic

Rosemary Dabbs

Gaurav Chauhan

Dr. Jonathan Boreyko

Dr. Brandon Razooky

Dr. Jason Fowlkes



U.S. DEPARTMENT OF
ENERGY

Office of Science





thank you. questions?